

product selection guide

- FENCE
- RAILINGS
- POST & RAIL
- ARBORS
- PERGOLAS
- CUSTOM



WHOLESALE FENCE

INTERSTATE

QUALITY BOUNDARIES... ENDLESS POSSIBILITIES.

Interstate Vinyl Products manufactures our *Visions* vinyl fence line in Amityville, New York.

ABOUT INTERSTATE

Our products are distributed to a select group of preferred fence contractors and distributors throughout the Northeast. Our goal is to deliver quality products which are designed to perform and meet expectations for security and beauty now and into the future. Before you make a decision on the vinyl fence products you will be investing in for your home or business, ask your fence contractor to show you our product samples and see for yourself the Interstate difference. Our Visions fence products reflect our dedication to quality.



THE INTERSTATE DIFFERENCE

Our Diverse Product Line: Available in an extensive line of styles, heights and seven colors; white, tan, adobe, gray and 3 wood grains, our Visions fence line offers infinite combinations. Suitable for a wide range of vinyl fence, railing, and pool safety applications, any Interstate dealer can recommend the right fence for each and every project.



Customization: Our complete line of vinyl fence, railings, arbors and gates can be customized. When an off the shelf product simply will not do, we offer a build-to-order customized solutions to meet the most challenging set of on-site conditions and/or needs.



Engineered Products: Our vinyl fence products are manufactured using the highest grade raw materials formulated to withstand the harsh conditions found in the Northeast. Our products are engineered with more ribs, of a heavier gauge vinyl, and are reinforced with galvanized steel stiffeners.





WHAT MAKES OUR VINYL FENCE BETTER

"The Bitterness Of Poor Workmanship Is Long Remembered After The Sweetness Of A Cheap Price Is Forgotten."



MID-RAIL: All privacy styles with a topper are manufactured with a 2" x 6" double-ribbed mid-rail. This mid-rail with its ridge design is a key component for Interstate's interlocking fence sections.

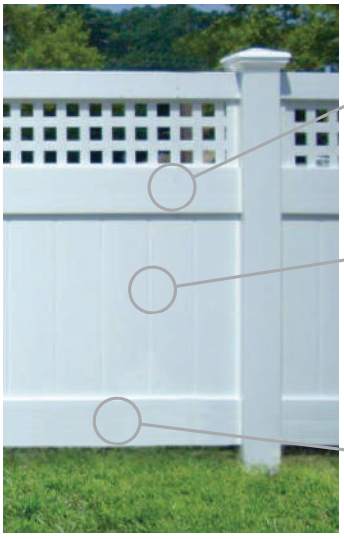

INTERLOCKING PANELS: Our fence sections use an interlocking construction which locks the vertical boards into the bottom and mid-rail. Our patented 2" x 6" rails have a ridge feature that allows this interlocking system to protect sections from knock-out and wind blowouts.

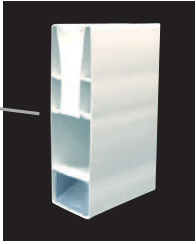

BOTTOM RAIL: The foundation of all of our PVC sections is our patented 2" x 6" heavy duty bottom rail with an internal steel support. This rail also features a ridge design for interlocking ability. The increased structural strength of this rail reduces sagging, premature failure, and damage from wind.

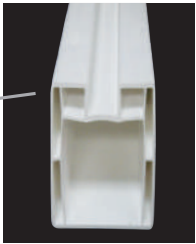

GATE FRAME: Vinyl gates have always been an area of product failure within the vinyl fence industry. All of our gates are manufactured using our patented 3 1/2" x 3 1/2" gate master frame. Its double walled feature enables hardware screws to penetrate two layers of the frame, as well as doubling the welding surface. This makes for stonger connections and reducing screws from pulling out. This gate master design is structurally stronger than that of our competitor's hollow or narrow gate frames. Bottom Line: *Our gates last longer!*



GATE STOP: This positive stop, patented by Interstate, is an additional piece of gate hardware that you will only find in our system. This stop is an insurance policy for all gates as it absorbs the violent act of the gate slamming and many times help protect against the resulting stress fractures and gate failure. Our gate stop is included with every walk and drive gate.

PRIVACY STYLES | OKLAHOMA

The **Oklahoma Style** is the most commonly sold vinyl fence style for its diverse applications and maximum privacy. These sections are manufactured with our full privacy interlocking tongue & groove board and heavy duty 2" x 6" steel reinforced bottom rail. We offer the Oklahoma fence and matching gate in scalloped and crowned designs.

The Oklahoma Privacy styles are available in heights ranging from 3 to 8 feet. Matching gates are available.

Color options available:



OKLAHOMA | WHITE



OKLAHOMA with WALK GATE | WHITE



OKLAHOMA with WALK GATE | 2 Tone



OKLAHOMA with WALK GATE | GRAY



OKLAHOMA with DIAGONAL MINI LATTICE TOPPER | 2 Tone



OKLAHOMA with MINI DIAGONAL LATTICE CROWNED | WHITE



OKLAHOMA with SQUARE MINI LATTICE TOPPER | WHITE



OKLAHOMA with SQUARE LATTICE TOPPER | 2 Tone



OKLAHOMA DELUXE DIAGONAL LATTICE & CROWNED WALK GATE | WHITE



OKLAHOMA with OLD ENGLISH LATTICE with 1 1/2' Topper | WHITE



OKLAHOMA with CLOSED SPINDLE TOPPER | WHITE



OKLAHOMA with CLOSED SPINDLE with DOUBLE DRIVE GATE | WHITE



OKLAHOMA with OPEN SPINDLE | WHITE



OKLAHOMA with SCALLOPED OPEN SPINDLE TOPPER | 2 Tone



OKLAHOMA with OPEN SPINDLE with CROWNED WALK GATE | WHITE



OKLAHOMA with STEPPED SPINDLE TOPPER | WHITE

SEMI-PRIVACY STYLES | SOUTH DAKOTA

Our South Dakota Style can stand on its own, or with one of our topper designs. The section comes with 7/8" x 6" picket, 2" x 6" top rail and 2" x 6" steel reinforced bottom rail.

Standard spacing is 5/8" or can be modified with custom spacing of your choice. Matching gates are available.

Color options available:



Select Semi-privacy styles 5'H and up come with 3 rails with your choice of "High Rail" or "Mid-Rail" placement.



SOUTH DAKOTA | 2 Tone



SOUTH DAKOTA with WALK GATE | WHITE



SOUTH DAKOTA with DIAGONAL LATTICE with WALK GATE | WHITE



SCALLOPED SOUTH DAKOTA with CLOSED SPINDLE TOPPER with WALK GATE | WHITE

SEMI-PRIVACY STYLES | ADDITIONAL

Color options available:



CALIFORNIA S-SWEPT | TAN | *Not Available in Gray or Wood Grains



CALIFORNIA with WALK GATE | WHITE | *Not Available in Gray or Wood Grains



OLD ENGLISH LATTICE | WHITE | *Not Available in Gray or Wood Grains



OLD ENGLISH LATTICE with WALK GATE | WHITE | *Not Available in Gray or Wood Grains

SEMI-PRIVACY STYLES | COLORADO

Our **Colorado Style** can also stand on its own, or with one of our topper designs of choice. The section offers an overlapping vertical board design using 7/8" x 6" pickets, 3-1/2" x 3-1/2" top rail, mid and steel reinforced bottom rail.

Standard spacing is 4-1/2" or can be modified with custom spacing of your choice. Matching gates are available.

Color options available:



COLORADO | WHITE



COLORADO with WALK GATE | WHITE



COLORADO with MINI DIAGONAL LATTICE TOPPER | WHITE



COLORADO with CLOSED SPINDLE TOPPER | 2 Tone

SEMI-PRIVACY STYLES | ADDITIONAL



TEXAS | WHITE | *Not Available in Gray or Wood Grains



TEXAS with HIGH RAIL & ARCHED GATE | WHITE | *Not Available in Gray or Wood Grains

Color options available (Texas):



Color options available (New Jersey):



NEW JERSEY | CEDAR GRAIN



NEW JERSEY with WALK GATES | WHITE

HORIZONTAL PVC FENCE STYLE | HAWAII

Our **Hawaii Horizontal Fence** offers a modern semi-privacy look. The section offers a 7/8" x 3" picket, or optional 7/8" x 6" picket, 3-1/2" top rail and 3-1/2" steel reinforced bottom rail.

Standard spacing is 5/8" or can be modified with custom spacing of your choice. Matching gates are available.

Color options available:



HAWAII | WHITE



HAWAII | CEDAR GRAIN



HAWAII | WHITE



HAWAII with WALK GATE | GRAY



HAWAII | WHITE



HAWAII with OPTIONAL 7/8" X 6" BOARD | WHITE

HORIZONTAL PVC FENCE STYLE | FLORIDA

Our **Florida Horizontal Fence** is a full privacy modern design. The section offers a 7/8" x 11-1/4" tongue and groove picket, 3-1/2" top rail, and 3-1/2" steel reinforced bottom rail.

Matching gates are available.

Color options available:



FLORIDA | GRAY



FLORIDA | GRAY



FLORIDA with HAWAII GATE | GRAY



FLORIDA with HAWAII GATE | GRAY

HORIZONTAL PVC FENCE STYLE | NEVADA

Our **Nevada Horizontal Fence** provides privacy and airflow while maintaining a stylish, modern look. The section features overlapping 7/8" x 6" boards and measures 6 feet wide.

Matching gates are available.

Color options available:



NEVADA | WHITE



NEVADA | CEDAR GRAIN

WOOD GRAIN AND COLOR FENCES

Our Wood Grain Vinyl Fence is unlike any other PVC fence on the market today! We offer an extensive line of Wood Grain fence styles and gates to satisfy your rear and front yard as well as pool enclosure fence needs. We have developed this product to look like natural wood, with the low maintenance advantages of vinyl. Through advancements in vinyl and acrylic materials, our Wood Grain Vinyl Fence line will last and outperform that of wood and other similar vinyl fence products well into the future. See for yourself how our products will surpass other composite and painted products on the market.

Matching gates are available.

Color options available:



OKLAHOMA | CEDAR GRAIN



OKLAHOMA with WALK GATE | CEDAR GRAIN



OKLAHOMA with LATTICE | CEDAR GRAIN



OKLAHOMA with CLOSED SPINDLE GATE | CEDAR GRAIN



OKLAHOMA with OPEN SPINDLE with WALK GATE | CEDAR GRAIN



4'H ILLINOIS | CEDAR GRAIN



OKLAHOMA | CYPRESS



OKLAHOMA with CLOSED SPINDLE with DOUBLE DRIVE GATE | CYPRESS



ILLINOIS | CYPRESS



ILLINOIS | CYPRESS



OKLAHOMA | SANDSTONE



OKLAHOMA with LATTICE with WALK GATE | SANDSTONE



OKLAHOMA with LATTICE | SANDSTONE



OKLAHOMA with CLOSED SPINDLE with WALK GATE | SANDSTONE

PICKET STYLES | ILLINOIS

We offer our Picket styles in heights ranging from 2 to 6 feet.

The **Illinois** section is a through rail style spaced picket offering straight, scalloped, or crowned picket design. The section comes with 2" x 2" pyramid capped square pickets and a 2" x 6" steel reinforced bottom rail. Standard spacing is 2" or can be modified with custom spacing of your choice.

Matching gates are available.

Color options available:



ILLINOIS | WHITE



ILLINOIS | WHITE



ILLINOIS SCALLOPED with WALK GATE | WHITE



ILLINOIS CROWNED | WHITE

PICKET STYLES | CONNECTICUT

The **Connecticut** section is a through rail style spaced picket offering a stepped picket design. The section comes with 2" x 2" pyramid capped pickets and a 2" x 6" steel reinforced bottom rail. Standard spacing is 2" or can be modified with custom spacing of your choice.

Matching gates are available.

Color options available:



CONNECTICUT | WHITE



CONNECTICUT TAPERED SECTION | WHITE

PICKET STYLES | ARIZONA

The **Arizona** is in the spaced picket spindle family and offers a rustic design that is available with both rows of spindles being straight or one row scalloped or crowned. It's up to you, we build to please.

Matching gates are available.

Color options available:



ARIZONA STRAIGHT TOP & SCALLOPED BOTTOM PICKETS | WHITE



ARIZONA STRAIGHT TOP PICKETS | WHITE



ARIZONA WITH SCALLOPED BOTTOM SPINDLE
DOUBLE DRIVE GATE | WHITE



ARIZONA STRAIGHT TOP & SCALLOPED BOTTOM | WHITE

PICKET STYLES | ARKANSAS

The **Arkansas** is much like the Kansas railing except it comes in heights of 3' to 6' and your choice of picket spacing of 1", 1 1/2", 1 3/4", 2", 3" and 4" giving you an array of options to suit your wants and/or needs.

Matching gates are available.

Color options available:



ARKANSAS T-RAIL TOP | WHITE | T-RAIL TOPS *Not Available in Gray or Wood Grains



ARKANSAS with 2" x 3 1/2" TOP & BOTTOM RAIL | WHITE



ARKANSAS RADIUS | WHITE

All spacing measurements are approximate.

PICKET STYLES | SOUTH CAROLINA

The **South Carolina** section is a through rail style spaced picket offering straight, scalloped, stepped, or crowned picket design. The section comes with 7/8"x3" "dog ear" pickets and a 2" x 6" steel reinforced bottom rail. Standard spacing is 2" or can be modified with custom spacing of your choice.

Matching gates are available.

Color options available:



SOUTH CAROLINA | WHITE



SOUTH CAROLINA with WALK GATE | WHITE



SOUTH CAROLINA DOUBLE DRIVE GATE | WHITE



SOUTH CAROLINA SCALLOPED | WHITE



SOUTH CAROLINA SCALLOPED | WHITE



SOUTH CAROLINA SCALLOPED with WALK GATE | WHITE



SOUTH CAROLINA SCALLOPED | ADOBE



SOUTH CAROLINA SCALLOPED & CROWNED | 2 TONE

PICKET STYLES | NORTH CAROLINA

The **North Carolina** section is a through rail style spaced picket offering straight, scalloped, stepped, or crowned picket design. The section comes with 7/8" x 3" "pointed" pickets and a 2" x 6" steel reinforced bottom rail. Standard spacing is 2" or can be modified with custom spacing of your choice.

Matching gates are available.

Color options available:



NORTH CAROLINA | WHITE



NORTH CAROLINA | WHITE



NORTH CAROLINA | WHITE



NORTH CAROLINA SCALLOPED | WHITE

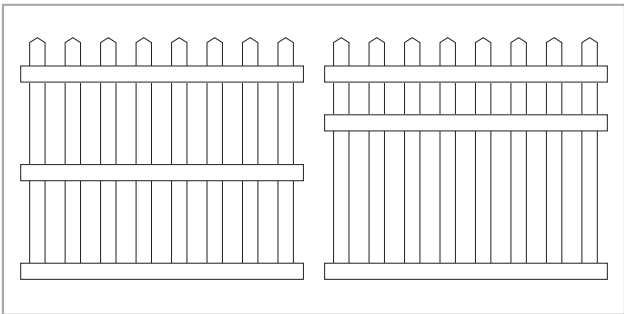

Spaced picket and select Semi-privacy styles 5'H and up come with 3 rails with your choice of "High Rail" or "Mid-Rail" placement.

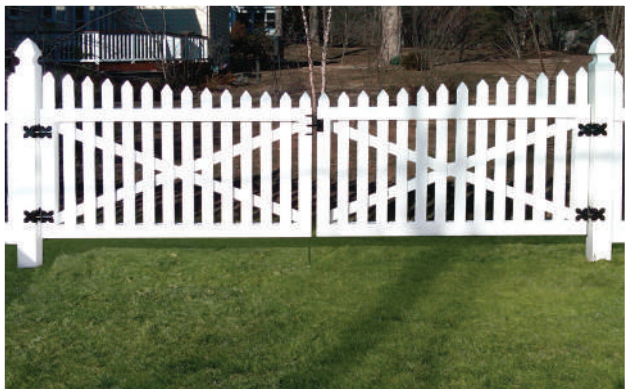

NORTH CAROLINA SCALLOPED DOUBLE GATE [Single Scallop] | WHITE

All spacing measurements are approximate.

PICKET STYLES | ALABAMA AND LOUISIANA

The **Alabama and Louisiana** styles offer the classic charm of a wood fence with its "Nail-On" design without the maintenance. Both Alabama (Dog Ear) and Louisiana (Pointed) pickets are 7/8" x 3" riveted to a 2" x 3-1/2" back rail. Standard spacing is 2" or can be modified with custom spacing of your choice.

Matching gates are available.

Color options available (Alabama):



ALABAMA | WHITE



LOUISIANA | WHITE



ALABAMA WALK GATE | WHITE

Color options available (Louisiana):



ALABAMA SCALLOPED | WHITE



LOUISIANA SCALLOPED | WHITE



LOUISIANA WALK GATE | WHITE

PICKET STYLES | WASHINGTON

The **Washington** style is a 1" x 1" alternating picket style with a "Boy Scout" finial design. Standard spacing is 4" or can be modified with custom spacing of your choice.

Matching gates are available.

Color options available:



WASHINGTON | WHITE | *Not Available in Gray or Wood Grains

POST & RAIL

Our Post & Rail is an affordable option for dividing large properties, great along roadways, and as a corral for horses and livestock. Post & Rail styles are available in 2-Rail, 3-Rail, and 4-Rail fencing. Standard Post & Rail and Cross Buck are a 2 by 6 rail with 5 by 5 posts. Diamond Rail is a 3 1/4" x 3 1/4" rail, also with 5 x 5 posts.

Matching gates are available.

Color options available (depending on style):



STANDARD POST & RAIL with added WELDED WIRE | WHITE |
Offered in 2 – 4 horizontal rails



CUSTOM SPACED POST & RAIL | WHITE |
Offered in 2 – 4 horizontal rails



CROSS BUCK | WHITE



CROSS BUCK | WHITE



DIAMOND POST & RAIL | WHITE | Offered in 2 – 4 horizontal rails |
*Not Available in Gray or Wood Grains



DIAMOND POST & RAIL | WHITE | Offered in 2 – 4 horizontal rails |
*Not Available in Gray or Wood Grains

RAILINGS & PORCH POSTS | RAILING

Interstate's Railing Systems and Posts add safety to any deck, porch, or stairway, without sacrificing style and visual appeal. T-Rail Tops are not available in Gray or Cedar Grain.



KANSAS 2" X 3 1/2" TOP & BOTTOM RAIL | WHITE



KANSAS T-RAIL | WHITE



KANSAS T-RAIL | WHITE



RICHMOND 2" X 3 1/2" TOP & BOTTOM RAIL | WHITE



RICHMOND 2" X 3 1/2" TOP & BOTTOM RAIL | WHITE

RAILINGS & PORCH POSTS | SPINDLES



| KANSAS |



| RICHMOND |

**Color options available
(Kansas "standard top"
2" x 3.5" rail):**



**Color options available
(Kansas "t-rail" top):**



**Color options available
(Richmond spindles):**



RAILINGS & PORCH POSTS | NEWEL POSTS

Interstate's Railing Systems and Posts add safety to any deck, porch, or stairway, without sacrificing style and visual appeal. T-Rail Tops are not available in Gray or Cedar Grain.



KANSAS 2" X 3 1/2" TOP & BOTTOM RAIL | WHITE



RICHMOND T-RAIL | WHITE



RICHMOND T-RAIL | WHITE



RICHMOND T-RAIL | WHITE

RAILINGS & PORCH POSTS | NEWEL POSTS



| RECESSED | | RICHMOND |

Color options available (Richmond Newel & Porch posts available in 5x5 only):



Color options available (Recessed structural posts available in 6x6 only):

As a standard, all railings are spaced slightly less than 3 1/2"; custom spacing is available.



ARBORS

An Arbor is a great addition to any entranceway and can accent your fence or can stand on its own. Our Arbors are offered with both diagonal and square lattice side panels as well as custom side panel designs. Arbors are structurally strong enough to hang a walk gate and can be custom built to fit most gate openings. Available in stock sizes of 4' and 5' wide. As our standard, our Arbors are built with two heavy duty posts.

Color options available (Deluxe):



Color options available (Flat Top):



Color options available (Crowned):



DELUXE ARBOR WITH FULL MINI LATTICE SIDE PANEL | WHITE



DELUXE ARBOR | 2 Tone



DELUXE ARBOR | WHITE



DELUXE ARBOR | WHITE



DELUXE ARBOR | WHITE



DELUXE ARBOR with DELUXE LATTICE | 2 Tone



ARBOR with CUSTOM SIDES & EXTRA COLLAR ACCENT | WHITE



ARCH FOR GATE OPENING | WHITE



FLAT TOP ARBOR | CEDAR GRAIN



FLAT TOP ARBOR | 2 Tone



CROWNED ARBOR | WHITE

PERGOLAS

A Pergola is a great addition to any entranceway and can accent your fence or can stand on its own.

Our Pergolas are offered with both diagonal and square lattice side panels as well as custom side panel designs. Pergolas are structurally strong enough to hang a walk gate and can be custom built to fit most gate openings. Available in stock sizes of 3', 4' and 5' wide. Custom widths available up to 13'. As our standard, our Pergolas are built with two heavy duty posts.

Color options available:



STANDARD PERGOLA | WHITE



STANDARD PERGOLA with FULL LATTICE SIDE PANEL | WHITE



STANDARD PERGOLA | 2 Tone

CUSTOM PERGOLAS MADE TO ORDER • AVAILABLE UP TO 13' X 13'

Color options available:



PERGOLA FREE STANDING with RECESSED POSTS | WHITE



LARGE PERGOLA | WHITE



CUSTOM PERGOLA | WHITE



PERGOLA EXTRA LARGE with MIDDLE POSTS | WHITE



CUSTOM PERGOLA with 6.5" POSTS | WHITE



PERGOLA FREE STANDING | WHITE



LATTICE PERGOLA CLOSEUP | WHITE

TOPPER STYLES | Can be used with any Privacy and Semi-Privacy styles.

Color options available: 

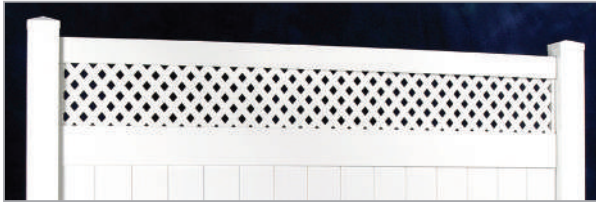

MINI DIAGONAL LATTICE | WHITE | *Not Available in Gray

Color options available: 

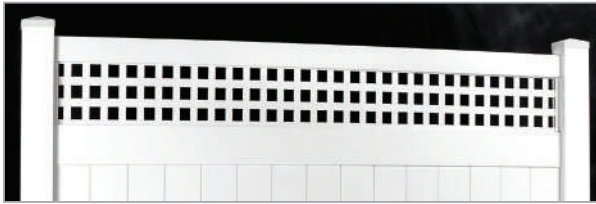

MINI SQUARE LATTICE | WHITE | *Not Available in Gray or Wood Grains

Color options available: 



CROWN DIAGONAL MINI LATTICE | WHITE | *Not Available in Gray or Wood Grains

Color options available: 

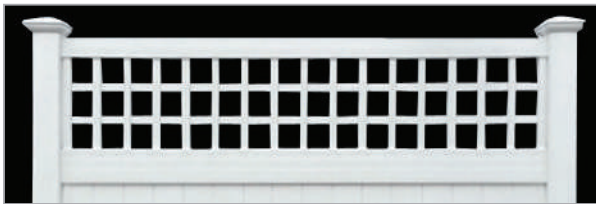

OLD ENGLISH | WHITE | *Not Available in Gray or Wood Grains

Color options available: 



OPEN SPINDLE | WHITE

Color options available: 



SCALLOPED OPEN SPINDLE | WHITE

Color options available: 

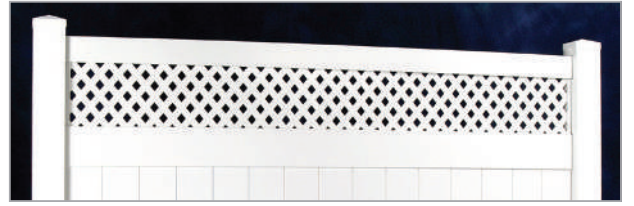

DELUXE DIAGONAL LATTICE | WHITE | *Not Available in Gray or Wood Grains

Color options available: 

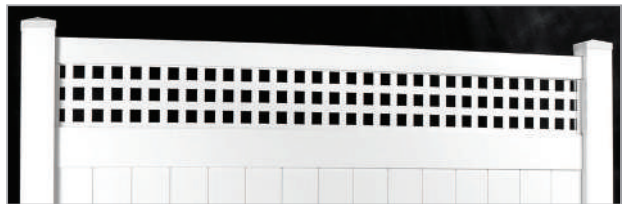

DELUXE SQUARE LATTICE | WHITE | *Not Available in Gray or Wood Grains

Color options available: 



SCALLOPED DIAGONAL MINI LATTICE | WHITE | *Not Available in Gray or Wood Grains

Color options available: 



CROWN OPEN SPINDLE | WHITE

Color options available: 



CLOSED SPINDLE | WHITE

Color options available: 



STEPPED OPEN SPINDLE | WHITE

GATES

Interstate's Gates are known in the industry as being one of the strongest welded PVC gates made. Our patented gate profile is a double-wall square profile, making it structurally stronger than any other on the market. With twice the surface for welding, and double the strength to secure hardware, our gates are not only more durable but also significantly more reliable, ensuring enhanced safety and longevity for any property they protect. Included with all our gates is our patented Positive gate stop to prevent slamming and ensure controlled closing, adding an extra layer of safety and convenience to our superior gate design.

Color options available (depending on style):



OKLAHOMA with GATE | WHITE



OKLAHOMA with CLOSED SPINDLE GATE | CEDAR GRAIN



OKLAHOMA with SCALLOPED OPEN SPINDLE
DOUBLE DRIVE GATE
[Each Leaf Scalloped] | 2 Tone



SOUTH DAKOTA DOUBLE DRIVE GATE
[Single Scallop] | WHITE



ILLINOIS SCALLOPED WALK GATE | WHITE



OKLAHOMA with MINI DIAGONAL LATTICE DOUBLE
DRIVE GATE [Single Scallop] | WHITE



ILLINOIS SCALLOPED DOUBLE DRIVE GATE
[Single Scallop] | WHITE

| INSIDE OF PATENTED GATE FRAME |

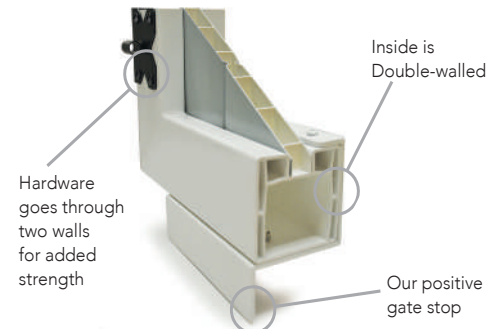

CUSTOM | SWEEPS • BENDS • RADIUS • DECO RAIL

Interstate Custom Products Put the finishing touches on designing your fence with a customized panel. Whether you have custom height or width needs, a space that transitions from one height to another, or just want to add a little flair, pick a style you love and let us build you the perfect custom fence.

Matching gates available.

Color options available (depending on style):



SWEPT TOP RAIL | ADOBE



S-SWEPT TOP RAIL | WHITE



CROWNED TOP RAIL | 2 TONE



S-SWEPT TWO RAIL SECTION | WHITE



SCALLOPED TOP RAIL | WHITE



SCALLOPED CLOSED SPINDLE & ARBOR | WHITE



4' RADIUS - 1/4 OF AN 8' CIRCLE | WHITE



SLOPE SWEPT with DELUXE DIAGONAL LATTICE | WHITE



S-SWEPT | WHITE



SCALLOPED TOP RAIL & SPINDLES | 2 TONE



TAPPERED | WHITE



TAPPERED 2 RAIL SECTION | WHITE



DECO RAIL | WHITE



SWEPT SPINDLE with STRAIGHT TOP RAIL | WHITE

HARDWARE

All of our hardware is available in White or Black, to match any of our fence colors. We also carry select items in Copper to complement our Cedar Grain color.

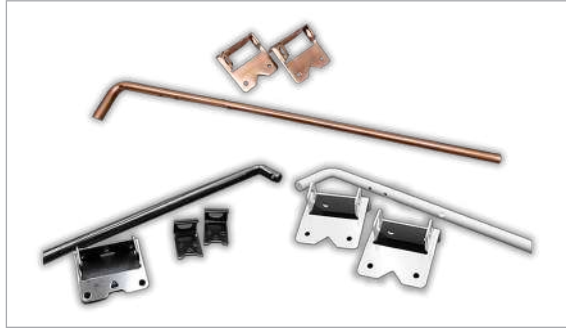

DROP RODS | AVAILABLE IN 24", 36" & 48"

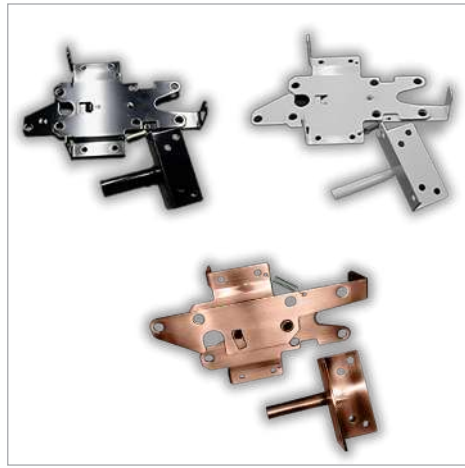

STAINLESS STEEL LATCHES



MAGNA LATCHES | AVAILABLE IN 10" & 20" | AVAILABLE IN BLACK & WHITE



HANDLES



KEY LATCHES



HINGES | REGULAR & SPRING LOADED HINGES AVAILABLE

POST CAPS



NEW ENGLAND



FEDERATION
*Not Available in Gray



GOTHIC



TRADITIONAL



BALL



SOLAR 4 BULB
*Available in White, Tan, Adobe & Copper
Adobe Special Order



HORSEHEAD
*Available in White & Tan only



FLOWER POT
*Available in White, Tan & Adobe only



The Interstate team sincerely appreciates your consideration of our company. We take great pride in the design and manufacturing of our fencing. With a history dating back to 1961, we bring extensive experience to deliver reliable and durable fencing solutions for your home or business.

When deciding on a fence for your property, consider requesting a sample to experience the quality difference. Despite the visual similarities among PVC fencing, our distinctiveness lies in our dedication to using only the highest quality materials made in the USA.



product selection guide

- FENCE
- RAILINGS
- POST & RAIL
- ARBORS
- PERGOLAS
- CUSTOM



| WHITE |

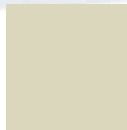

| TAN |



| GRAY |



| ADOBE |



| SANDSTONE |



| CYPRESS |

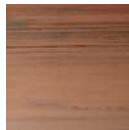

| CEDAR GRAIN |

*Please note that the colors in this brochure may vary from the actual product due to printing and display differences.
For a more accurate representation, please request a sample for accuracy.*



WHOLESALE FENCE

INTERSTATE

VISIONS

QUALITY BOUNDARIES... ENDLESS POSSIBILITIES.

1084 SUNRISE HIGHWAY
AMITYVILLE, NEW YORK 11701

www.interstatevisions.com

