

Illusions[®] Vinyl Fence

The Classic Face of the American Landscape

Beautify Your Outdoor Living Space • Enjoy Stylish Privacy & Security
Increase Your Property Value • 100% Pure Virgin Vinyl Fence



Why Illusions Vinyl Fence?

Because Your Home Deserves the Very Best!



You've done everything in your power to make your home fit your unique style.

Why would you settle for less from your fence?

You wouldn't. That's why Illusions Vinyl Fence is the perfect fit for your next fence installation. It's got everything you need all rolled up into a simple and affordable package.

As a part of the Eastern Fence Family with locations throughout the east coast, we have been manufacturing and distributing fence and railing products for almost 50 years. Your possibilities are endless when you choose your Illusions products.

Designed with the sole purpose of allowing your creativity to flow, Illusions Vinyl Fence allows you to Mix 'n' Match your color options to create unique variations to match your home or business.

To find out more information, check out the website: illusionsfence.com



www.illusionsfence.com

Why Illusions Vinyl Fence?



ASTM F964-13 Compliant

ASTM F964-13 is considered the most recognized testing specification for vinyl. The purpose of this specification is to establish a recognized standard of quality for exterior vinyl profiles for use in assembling agricultural, commercial, and residential fencing and railing.



QuickShip™ InStock NO-WAIT Program

Got an important party coming up and need a fence quick?

Many styles of Illusions Vinyl Fence and their matching 4' and 5' wide gates are in stock and available for immediate shipment. Ask your fence installer for information on all current options.



Ready to Specify

Illusions Vinyl Fence styles are available on www.CADDetails.com to help you immediately specify for commercial and residential installations. Spec sheets, CAD files, PDFs, and more are ready to help you get your Illusions Fence installed today!



Made in the U.S.A.

Manufactured by Eastern Wholesale Fence, Illusions Vinyl Fence has been a household name in the fence industry for almost 30 years and is proudly manufactured in the United States of America.



Warranty

The best looking products in the industry give you a great warranty as well!

Classic Illusions Fence is protected by a comprehensive limited lifetime warranty. For details and warranty related questions, please visit the Illusions fence website at www.illusionsfence.com.



www.illusionsfence.com



PRIVACY



CLASSIC WHITE V3215DS-6

Privacy Panels feature a “V”-Jointed tongue and groove board and come with a wide variety of decorative tops. Privacy fence panels include a metal reinforcement channel in the bottom rail to help create a stronger and longer lasting fence. We pride ourselves on offering a Privacy Panel for every taste.

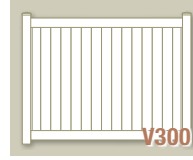

V300

PRIVACY

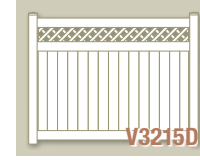

V3215D

PRIVACY WITH
DIAGONAL LATTICE

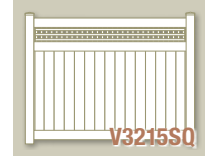

V3215SQ

PRIVACY WITH
SQUARE LATTICE

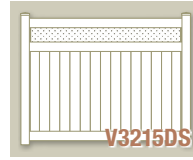

V3215DS

PRIVACY WITH
SMALL DIAGONAL
LATTICE

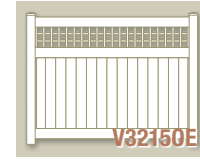

V32150E

PRIVACY WITH OLD
ENGLISH LATTICE

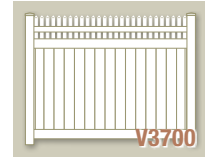

V3700

PRIVACY WITH
STRAIGHT
PICKET TOP

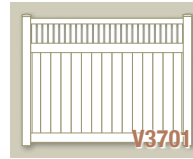

V3701

PRIVACY WITH
FRAMED
PICKET TOP

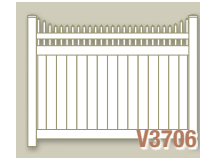

V3706

PRIVACY WITH
STEPPED
PICKET TOP

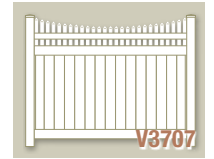

V3707

PRIVACY WITH
SCALLOPED
PICKET TOP



V300-6 IN CLASSIC BEIGE AND CLASSIC CLAY

PRIVACY



V3215D-6 IN CLASSIC GRAY AND CLASSIC WHITE



V3700-6 IN CLASSIC WHITE



V300-6 IN CLASSIC WHITE WITH
VBG4 GATE WITH SQUARE LATTICE



V300-6 IN CLASSIC BEIGE AND CLASSIC WHITE
WITH CLASSIC WHITE VARGB ARBOR WITH SQUARE LATTICE

SEMI-PRIVACY



HORIZONTAL SEMI-PRIVACY WITH 3" BOARDS



NEW!
V500H-KD
(Photo Page 25)

V5706-6 IN CLASSIC WHITE

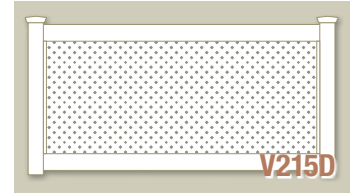

SMALL DIAGONAL LATTICE

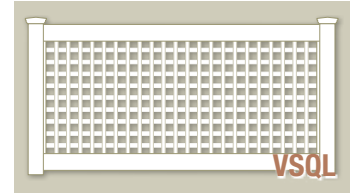

OLD ENGLISH LATTICE

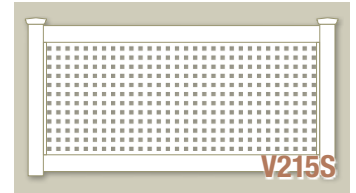

SQUARE LATTICE

The Illusions Vinyl Fence Semi-Privacy line has one of the largest selections offered and is specially designed for basic privacy without a "closed in" feeling. This extensive selection offers standard semi-privacy styles with space between the boards to allow air to flow through as well as the well known Board-on-Board styles with overlapping boards that provide both privacy and airflow.

Also popular in the Semi-Privacy series is "Old English Lattice." It's designed to look like a vinyl version of the common fence style used for growing vines, gardens, and hedgerows. Semi-Privacy fence panels include a metal reinforcement channel in the bottom rail to help create a stronger and longer lasting fence. Available in all Classic Colors.

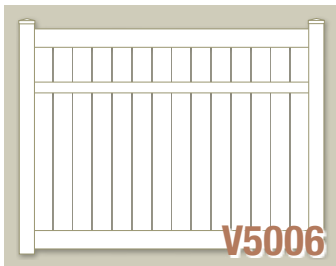

V5006
SEMI-PRIVACY WITH 6" BOARDS

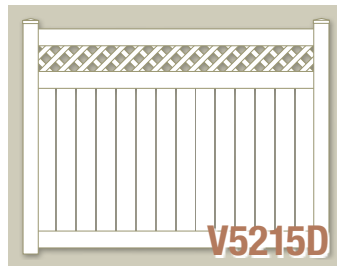

V5215D
SEMI-PRIVACY WITH 6" BOARDS AND DIAGONAL LATTICE

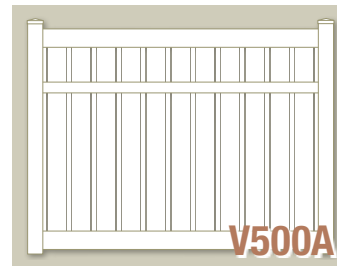

V500A
SEMI-PRIVACY WITH ALTERNATING 6" AND 1-1/2" BOARDS

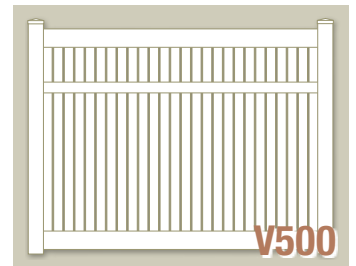

V500
SEMI-PRIVACY WITH 3" BOARDS

Board-On-Board Styles Use V300 or V500 Series Gates

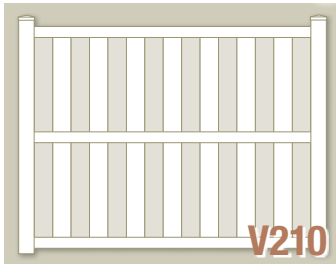

V210
BOARD ON BOARD

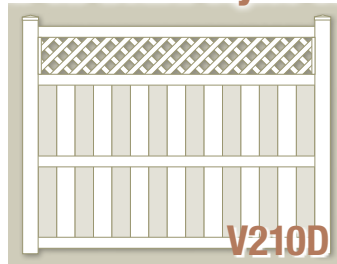

V210D
BOARD ON BOARD WITH DIAGONAL LATTICE

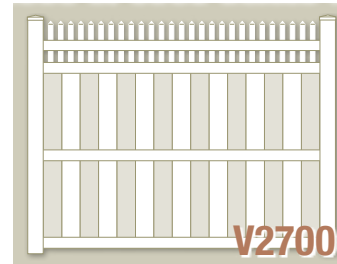

V2700
BOARD ON BOARD WITH STRAIGHT PICKET TOP

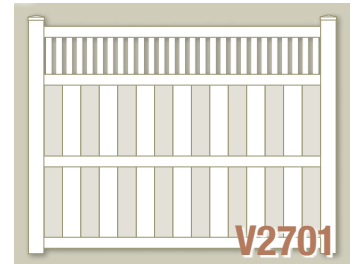

V2701
BOARD ON BOARD WITH FRAMED PICKET TOP

CLASSIC VICTORIAN PICKET



V707-4 IN CLASSIC WHITE

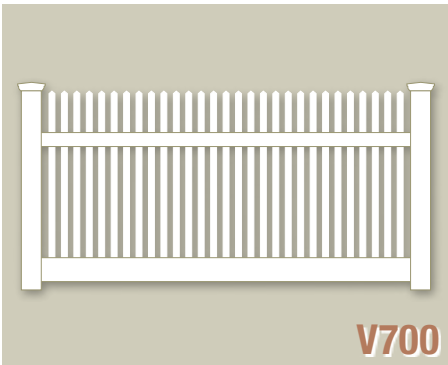

V700

1-1/2" X 1-1/2" STRAIGHT TOP PICKET

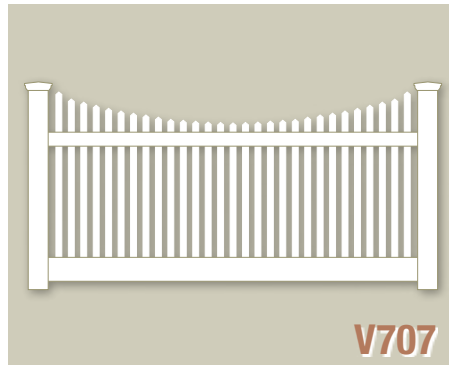

V707

1-1/2" X 1-1/2" SCALLOPED PICKET

One of the most popular fence styles in the USA is the Illusions Vinyl Fence Classic Victorian Picket.

Using 1-1/2" x 1-1/2" pickets, it is a maintenance-free look alike of the old red cedar fence. All of the panels are carefully designed with the classic look in mind and are available in all Classic Colors.

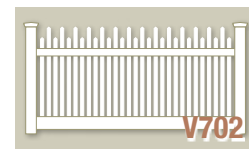

V702

1-1/2" X 1-1/2" STAGGERED TOP PICKET

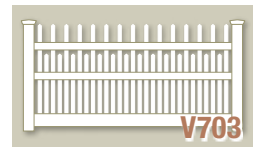

V703

1-1/2" X 1-1/2" STAGGERED PICKET

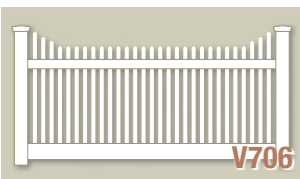

V706

1-1/2" X 1-1/2" STEPPED TOP PICKET

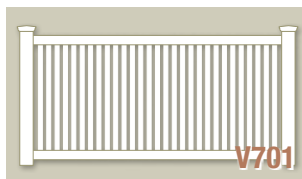

V701

1-1/2" X 1-1/2" FRAMED TOP PICKET

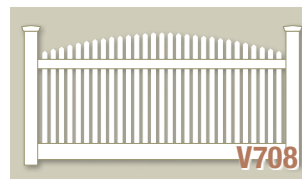

V708

1-1/2" X 1-1/2" ARCHED TOP PICKET



V703S

1-1/2" X 1-1/2" STAGGERED SCALLOPED PICKET



V705

1-1/2" X 1-1/2" FRAMED STAGGERED PICKET

CONTEMPORARY PICKET



V352-4 IN CLASSIC WHITE



V350-TR

7/8" X 3" PICKETS WITH DOG-EAR PICKET CAPS



V353-TR

7/8" X 3" ARCHED PICKETS W/ DOG-EAR PICKET CAPS



V401-TR

7/8" X 3" PICKETS W/ POINTED PICKET CAPS



V402-TR

7/8" X 3" SCALLOPED PICKETS W/ POINTED PICKET CAPS



V406-TR

7/8" X 3" STEPPED PICKETS W/ POINTED PICKET CAPS

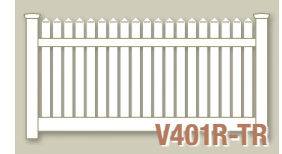

V401R-TR

7/8" X 3" PICKETS WITH POINTED PICKET CAPS (REDUCED SPACING)

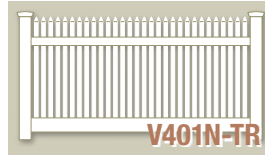

V401N-TR

7/8" X 1-1/2" PICKETS W/ POINTED PICKET CAPS

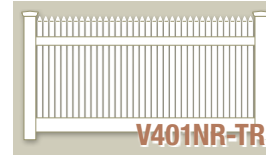

V401NR-TR

7/8" X 1-1/2" PICKETS W/ POINTED PICKET CAPS (REDUCED SPACING)

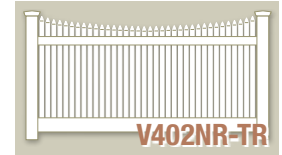

V402NR-TR

7/8" X 1-1/2" SCALLOPED W/ POINTED PICKET CAPS (REDUCED SPACING)

Illusions Contemporary Picket Fence offers what is known as the "good neighbor" approach to fencing. It is a fence that features both sides of the panels being exactly the same. The pickets are assembled THROUGH the rails instead of simply being attached to them. Available in all Classic Colors.

ORNAMENTAL PICKET



V0200-4 WITH BOY SCOUT PICKET TOPS IN CLASSIC BEIGE AND CLASSIC WHITE

Illusions Ornamental 1" x 1" Picket is a vinyl alternative to the wrought iron fence. It enables you to maintain the look of wrought iron without the maintenance. Available in all Classic Colors.

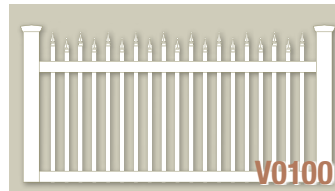

V0100

1" X 1" ORNAMENTAL PICKET FENCE WITH STAGGERED PICKET TOPS

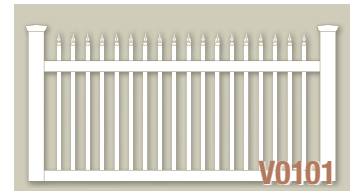

V0101

1" X 1" ORNAMENTAL PICKET FENCE WITH STRAIGHT PICKET TOP

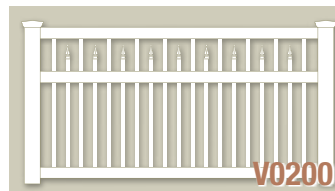

V0200

1" X 1" ORNAMENTAL PICKET FENCE WITH STAGGERED FRAMED PICKET TOP

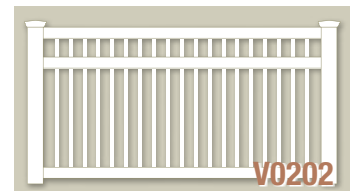

V0202

1" X 1" FRAMED TOP ORNAMENTAL PICKET FENCE

PICKET TOP STYLES



ARROWHEAD



BOY SCOUT



GOthic

POST & RAIL



3-RAIL POST & RAIL IN CLASSIC BEIGE

Illusions Post & Rail fence is available with three different styled rails for the Two-Rail, Three-Rail, Four-Rail or Crossbuck fence. Whatever setting you may have, Illusions has the look you want and the strength you need.



2-RAIL



3-RAIL



4-RAIL

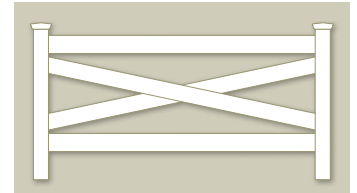

CROSSBUCK

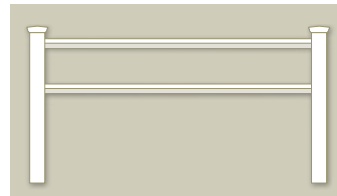

2-RAIL DIAMOND

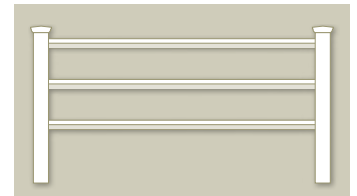

3-RAIL DIAMOND

RAILING



VRT6 3 IN CLASSIC CLAY

Illusions offers a complete line of vinyl railings. All Illusions Vinyl Railing System railing panels contain a metal channel in the top-rail. Illusions Vinyl Railings also offers an *optional* metal channel for the bottom rail for extra protection.

See page 27 for more information on Illusions Vinyl Railings.

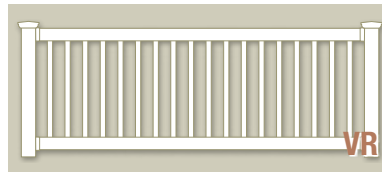

TRADITIONAL - 2" X 3.5" TOP-RAIL

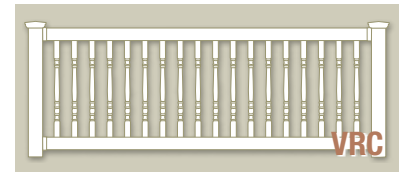

COLONIAL - 2" X 3.5" TOP-RAIL

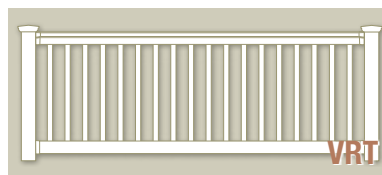

TRADITIONAL - T-RAIL TOP-RAIL

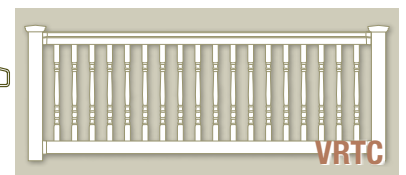

COLONIAL - T-RAIL TOP-RAIL

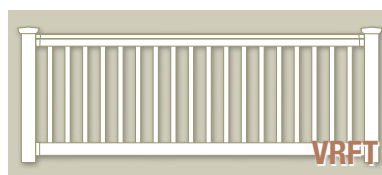

TRADITIONAL - FLAT T-RAIL TOP-RAIL

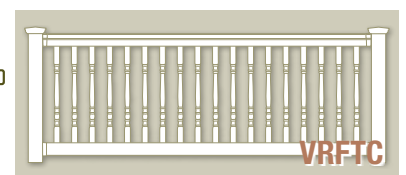

COLONIAL - FLAT T-RAIL TOP-RAIL

CURVES & TRANSITIONS

Simple to Order Matching Accessories for Your Illusions Vinyl Fence

Enhance the look and feel of your Illusions Vinyl Fence with these readily available curved and bent rails. Perfect for unique fence styles, transition sections, or for rounded corners of your property. All rails are available in all Classic Color options.

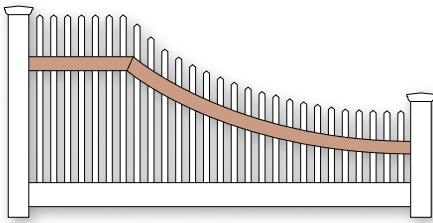

WATERFALL "A" SLOPE RAIL

Available in ALL fence styles

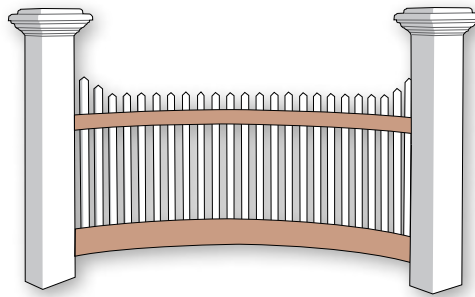

RADIUS "E" RAIL

Only available in picket fence styles

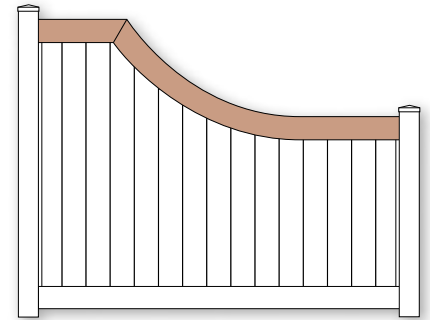

WATERFALL "H" RAIL

Available in all full privacy and Semi-privacy fence styles

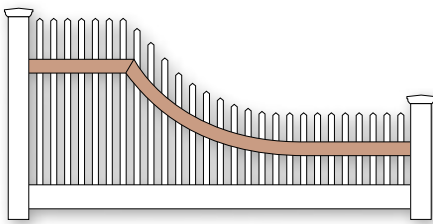

WATERFALL "B" SWEEP RAIL

Available in ALL fence styles

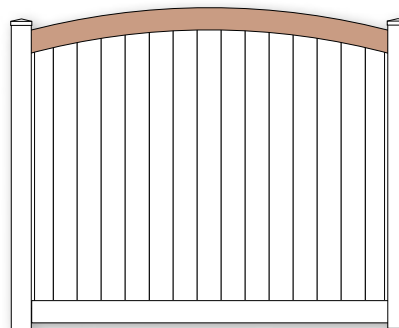

CROWNED "F" RAIL

Available in all full privacy and Semi-privacy fence styles

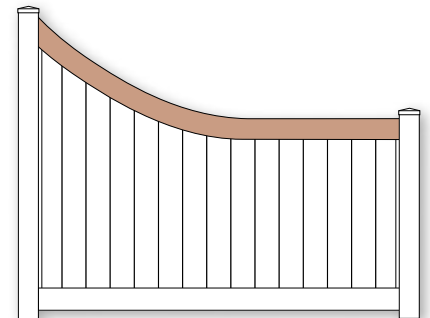

SWEEP "I" RAIL

Available in all full privacy and Semi-privacy fence styles

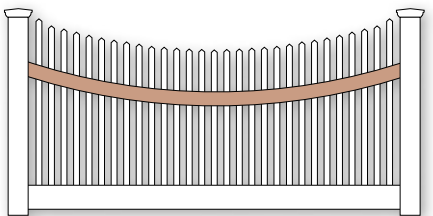

SCALLOPED "C" RAIL

Available in ALL fence styles

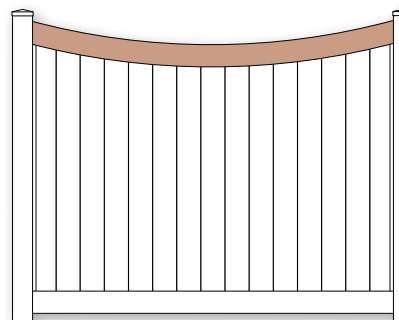

SCALLOPED "G" RAIL

Available in all full privacy and Semi-privacy fence styles

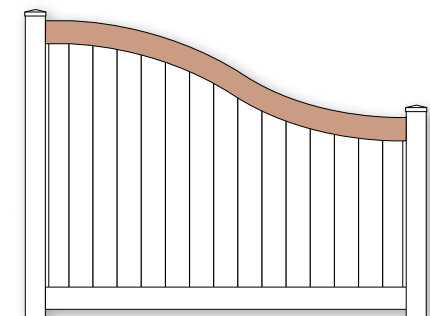

S-CURVED STYLED "J" RAIL

Available in all full privacy and Semi-privacy fence styles

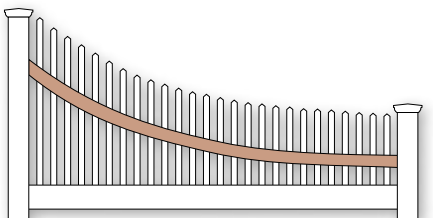

SWEEP "D" RAIL

Available in ALL fence styles

CURVES & TRANSITIONS

Simple to Order Matching Accessories for Your Illusions Vinyl Fence

Transition sections are used when you need to change the height of a fence run.
 Perfect for backyard to front yard height adjustments, ending sections, corner accents, and more!
 All rails are available in all Classic Color options.

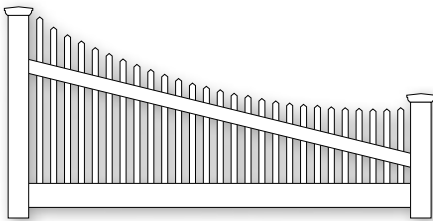

SW-A (Sweep Pickets / Angled Rail)
 Available in all picket fence styles

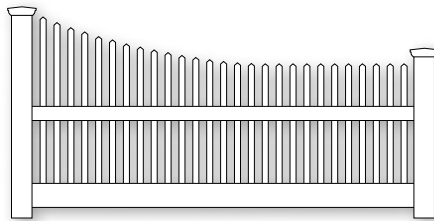

SW-S (Sweep Pickets / Straight Rail)
 Available in all picket fence styles

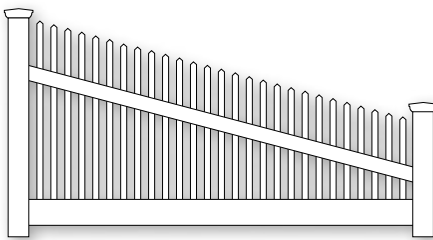

TAP-A (Tapered Pickets / Angled Rail)
 Available in all picket fence styles

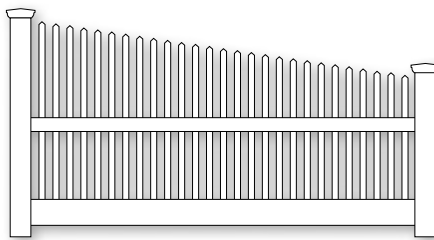

TAP-S (Tapered Pickets / Straight Rail)
 Available in all picket fence styles

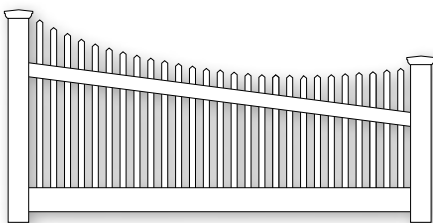

SCAL-A (Scalloped Pickets / Angled Rail)
 Available in all picket fence styles

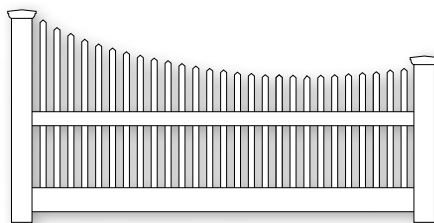

SCAL-S (Scalloped Pickets / Straight Rail)
 Available in all picket fence styles

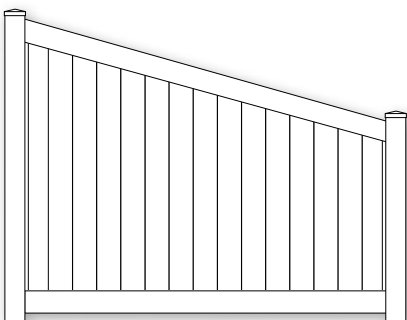

TAPER (Straight Taper)
 Available in all privacy and Semi-privacy styles

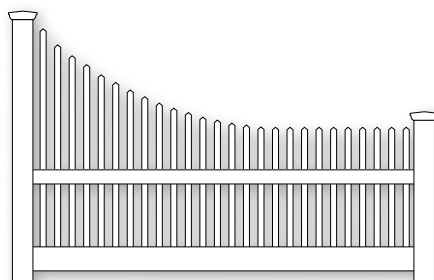

SL-S (Sloped Pickets / Straight Rail)
 Available in all picket fence styles



TRANSITION "J" RAILS

Illusions Classic V3215DS section with a transition s-curved "J" Rail top and mid-rails. Shown in Classic Gray and White.



"D" - RAIL

VBD300 Illusions Classic V300 section with a curved "D" Rail style transition top rail. Shown in Classic White.

MATCHING WELDED GATES

(Matching Assembled Gates Available
Ask Your Fence Installer for More Information)

PRIVACY

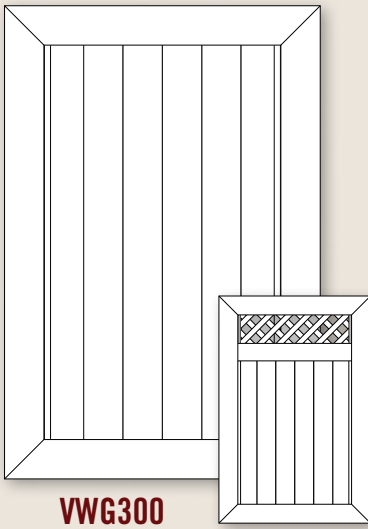

VWG300

VWG3215D

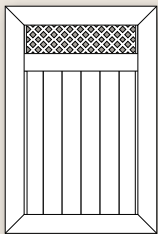

VWG3215DS

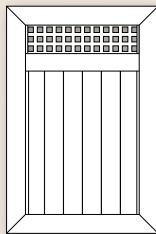

VWG3215SQ

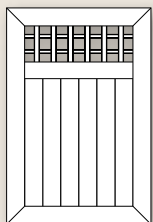

VWG32150E

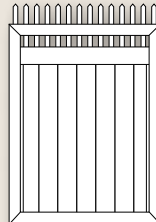

VWG3700

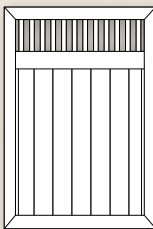

VWG3701

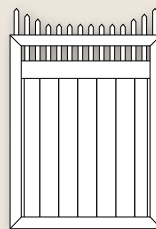

VWG3706

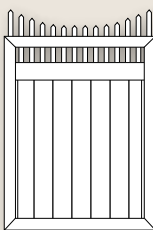

VWG3707

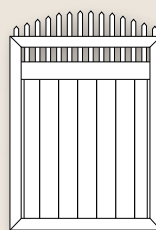

VWG3708

SEMI-PRIVACY

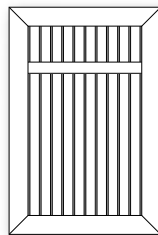

VWG500

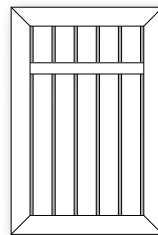

VWG5006

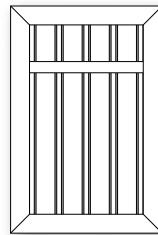

VWG500A

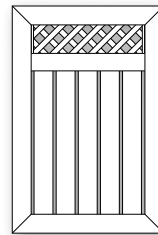

VWG5215D

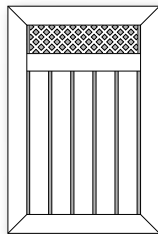

VWG5215DS

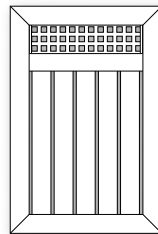

VWG5215SQ

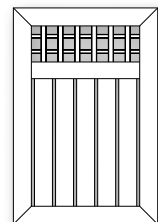

VWG52150E

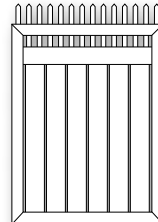

VWG5700

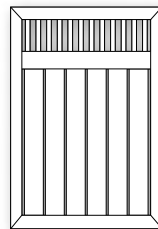

VWG5701

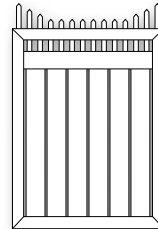

VWG5706

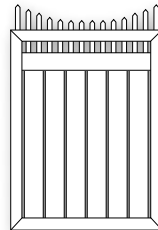

VWG5707

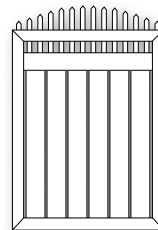

VWG5708

BOARD-ON-BOARD



VWG210

VWG210D



VWG210DS



VWG210SQ



VWG2700



VWG2701



VWG2706



VWG2707

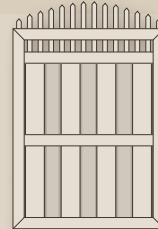

VWG2708

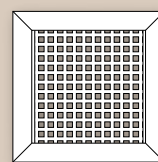

VWG215S

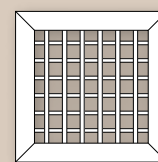

VWGSQL

LATTICE

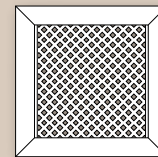

VWG215D

B-o-B
Styles
Use
V300
or
V500
Series
Gates

CLASSIC VICT. PICKET

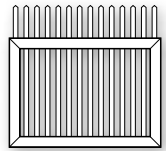

VWG700

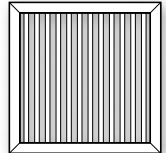

VWG701

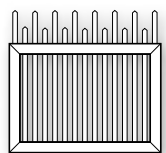

VWG702

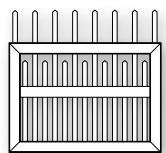

VWG703

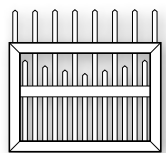

VWG703S

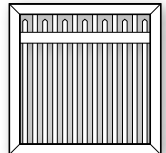

VWG705

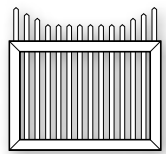

VWG706

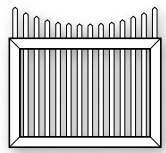

VWG707

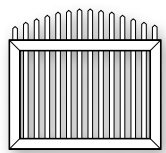

VWG708

MATCHING WELDED GATES

(Matching Assembled Gates Available
Ask Your Fence Installer for More Information)

Standard 3' & 4' Width Walk Gates (VWG), and 5' & 6' Width Drive Gates (VDG) (Custom Sizes and Styles Available)

ACCENT GATES

CONTEMPORARY PICKET

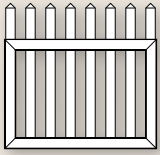

VWG401-TR

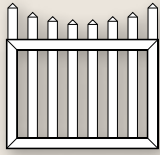

VWG402-TR

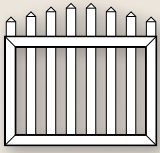

VWG403-TR

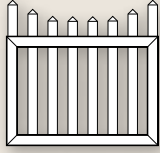

VWG406-TR

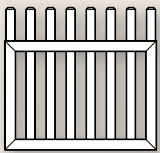

VWG350-TR

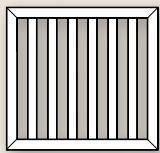

VWG351-TR

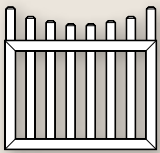

VWG352-TR

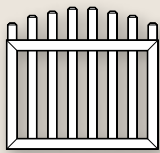

VWG353-TR

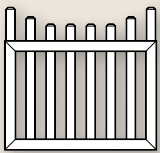

VWG356-TR

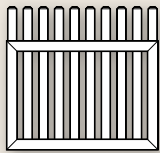

VWG353R-TR

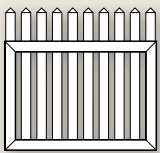

VWG401R-TR

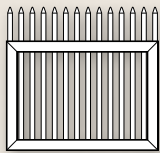

VWG401N-TR

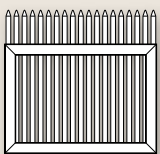

VWG401NR-TR

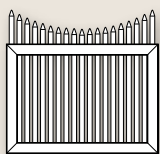

VWG402NR-TR

ORNAMENTAL PICKET

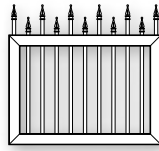

VWG0100

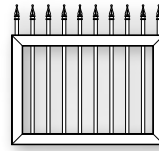

VWG0101

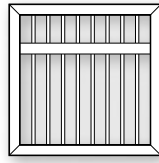

VWG0202

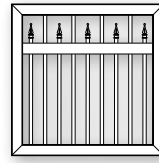

VWG0200

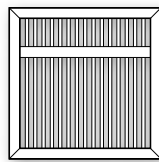

VWG0402

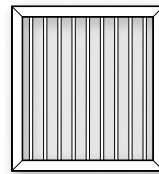

VWGOV52

POST AND RAIL



V2RWG

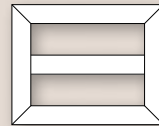

V3RWG

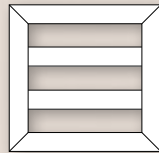

V4RWG

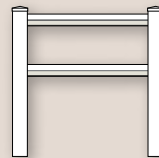

VDRG-42

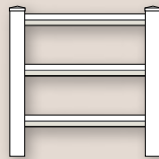

VDRG-43

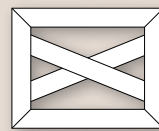

VWGCB



ASSEMBLED GATES FOR SELECT STYLES

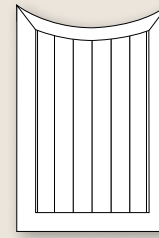

VBG1

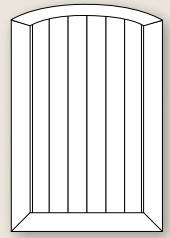

VBG2

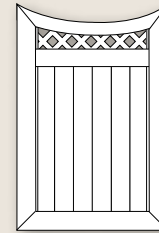

VBG3

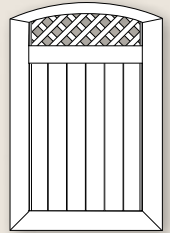

VBG4

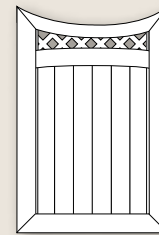

VBG5

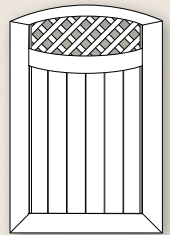

VBG6

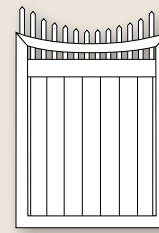

VBG7

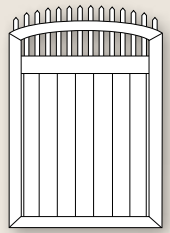

VBG8

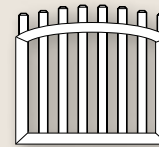

VBG10

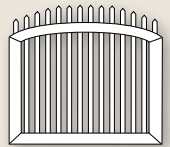

VBG11

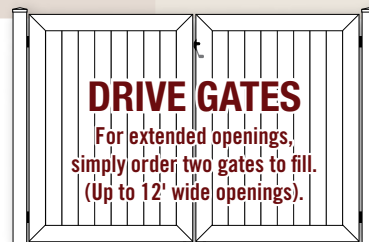

DRIVE GATES

For extended openings,
simply order two gates to fill.
(Up to 12' wide openings).

(Shown: Two 5' Wide VDG300-56)

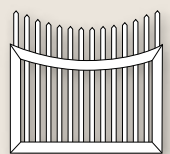

VBG12

ARBORS & PERGOLAS

Illusions Arbors & Pergolas are an important option to help add flair to your fence installation by taking it from a good looking fence install to a great looking fence install in one simple step. Use with a gate or as a fun ornament for your landscaping.

AVAILABLE
IN
ALL
CLASSIC
COLOR
OPTIONS!

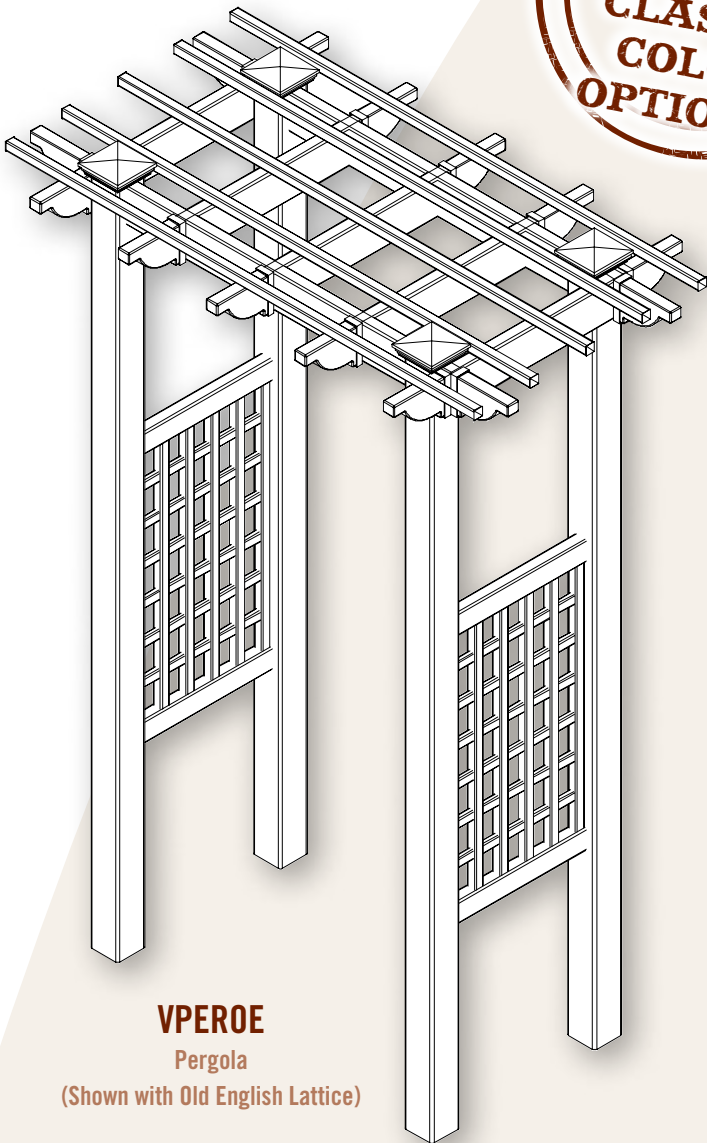

VPEROE
Pergola
(Shown with Old English Lattice)

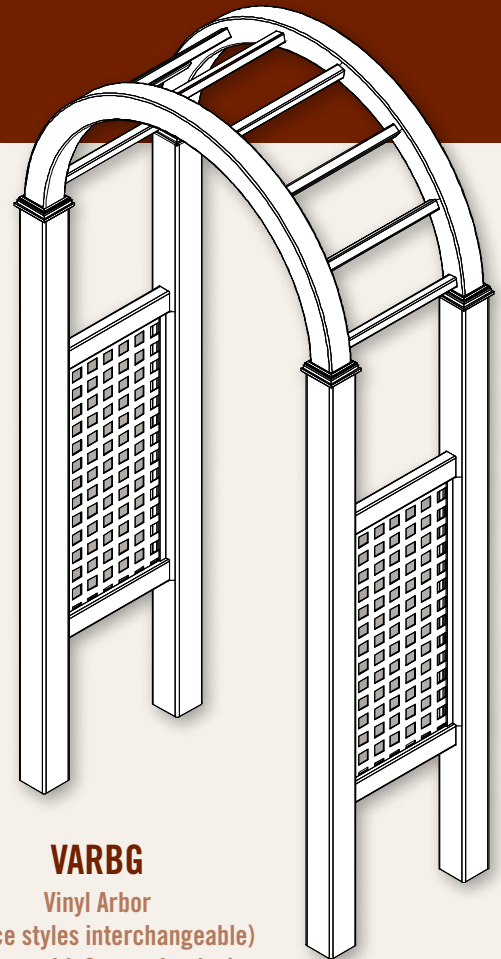

VARBG
Vinyl Arbor
(Lattice styles interchangeable)
(Shown with Square Lattice)

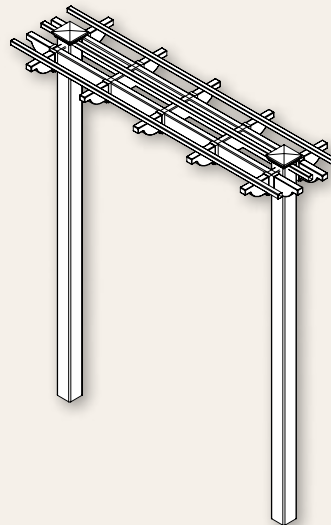

VPER2P
2 Post Pergola

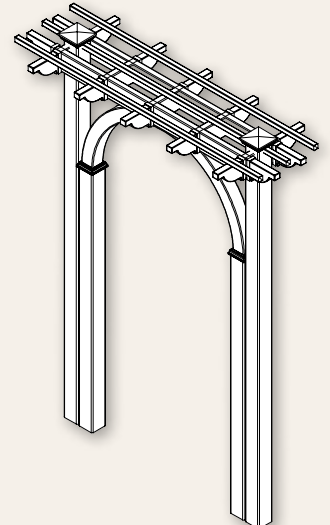

VPER4P
4 Post Pergola with Arch

ARBORS & PERGOLAS



V3707-6 6' high privacy fence with scalloped Classic Victorian Picket top and matching VWG3707-46 walk gate and VPER0E pergola with Old English Lattice. All shown in Classic Clay and Classic White.



VPER2P



VARBG (Diagonal Lattice)



VARBG (Small Diagonal Lattice)



VPER4P

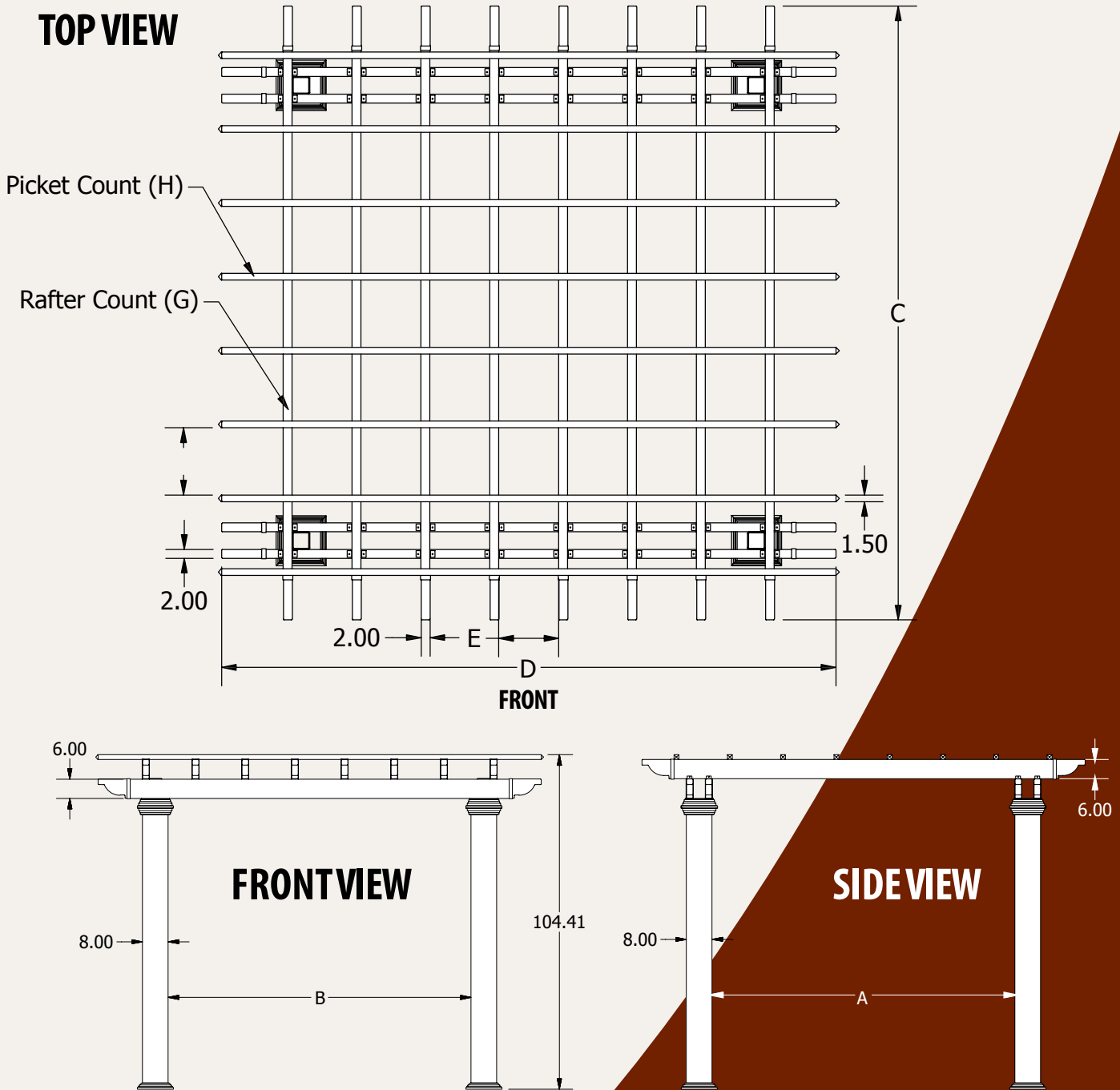

Measurement	A	B	C	D	E	F	G	H
Kit Size	Inches	Inches	Inches	Inches	Inches	Inches	Pieces	Pieces
8' x 8'	70"	70"	114.2"	114.2"	12"	13.95"	7	7
8' x 12'	70"	118.75"	114.2"	162.2"	12.75"	13.95"	10	7
10' x 10'	94.5"	94.5"	138.2"	138.2"	13.5"	15.171"	8	8
10' x 12'	94.5"	118.75"	138.2"	162.2"	12.75"	15.171"	10	8
12' x 12'	118.75"	118.75"	162.2"	162.2"	12.75"	16.088"	10	9

PERGOLA KITS



**AVAILABLE
IN
ALL CLASSIC
COLOR
OPTIONS!**

Perfect for any setting, Illusions Pergola Kits can be installed both inground or surface mount.

Item #	Description
VPK88	8' x 8' Vinyl Pergola Kit (Inground)
VPK1010	10' x 10' Vinyl Pergola Kit (Inground)
VPK1212	12' x 12' Vinyl Pergola Kit (Inground)
VPK812	8' x 12' Vinyl Pergola Kit (Inground)
VPK1012	10' x 12' Vinyl Pergola Kit (Inground)
VPKM88	8' x 8' Vinyl Pergola Kit with Post Inserts (Surface Mount)
VPKM1010	10' x 10' Vinyl Pergola Kit with Post Inserts (Surface Mount)
VPKM1212	12' x 12' Vinyl Pergola Kit with Post Inserts (Surface Mount)
VPKM812	8' x 12' Vinyl Pergola Kit with Post Inserts (Surface Mount)
VPKM1012	10' x 12' Vinyl Pergola Kit with Post Inserts (Surface Mount)

Surface Mount Kits include all items necessary for fabrication EXCEPT fasteners



LOW VOLTAGE LIGHTING

Low Voltage Fence, Railing, & Deck Lighting Solutions

Illusions Vinyl Fence Low Voltage Lighting Caps and Hardware are made to combine safety and quality with aesthetics. Lighting is one way that customers can add a unique touch to their deck, fence, or railing. Illusions lighting products are constructed with only high grade, commercial components.

Illusions Low Voltage Lighting was created to provide contractors and homeowners LED lighting solutions that are easy to install, reliable, and affordable.

These attractive lighting components will increase the enjoyment of any outdoor living space while also adding ambiance and safety.

- Simple and Easy to Install
- No wires to cut - plug together wiring harness
- Single power supply for all lights
- No need for an electrician or electrical permits
- Weather resistant connectors and lights
- Long-lasting LED's
- Housings are durable and UV stable
- Low voltage DC power supply
- Dusk to dawn light sensor
- Available with remote dimmer switch



VNPCL55W

5" Neptune Halo LV Post Cap - White
0.80 Watts

Also available in 4"
VNPCL44W



0.80 Watts

VHPCL44W

4" Halo LV Light - White



0.80 Watts

VDPCL44W

4" Downward LV Post Cap - White



0.80 Watts

VCPC44W

4" Combo LV Post Cap Light

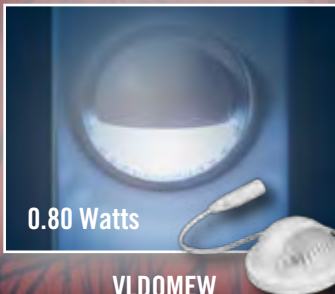

0.80 Watts

VLDOMEW

LV Dome Side Light - Scalloped Lens



0.40 Watts

VLSTW

LV Side/Stair Light (Comes with 2 Covers)

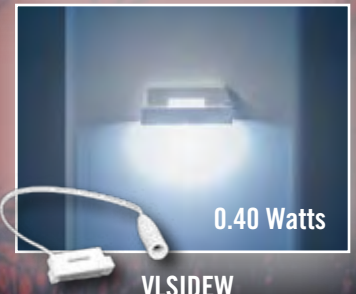

0.40 Watts

VLSIDEW

Ornamental LV Side Light



NEW!

Picket Caps

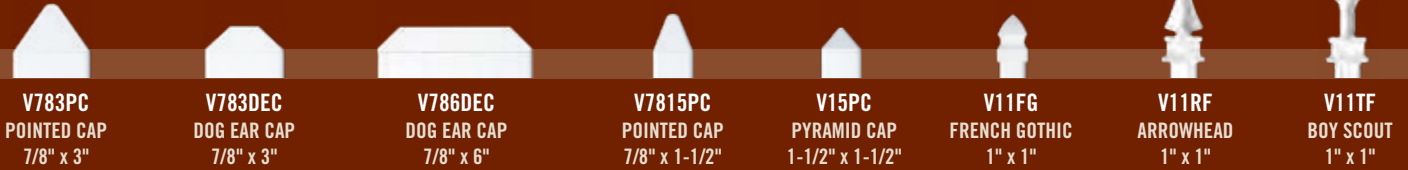

HARDWARE

Hinges

All Illusions Gate Hardware is custom designed to our specifications and manufactured using only the highest quality materials held to the same rigorous standards we use for all of our products. Many of our products are available in black, white, and bronze. Use a Vinyl Gate Stopper (VGS or VGSH) on all gates and two sets of Drop Rods (DRAS) on double drive gates.

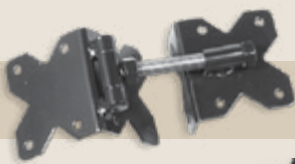

CPH55
CORNER PLATE HINGE
(Black or White)
(Sold in pairs)



CPH55S
SPRING LOADED CORNER
PLATE HINGE
(Black, White, or Bronze)
(Sold in pairs)



THSL
TRUE-CLOSE
SPRING HINGE
(Black Only)
(Sold in pairs)



THAHD-BK
ADJUSTABLE TRUE-CLOSE
SPRING HINGE
(Black or White)
(Sold in pairs)



IESH
X-TRA STRONG HINGE
(Black or White)
(Sold in pairs)

Latches



MLDD-BK
MAGNETIC GATE LATCHES
(Black or White)



MLS-BK
SMALL MAGNETIC GATE
LATCHES
(Black or White)

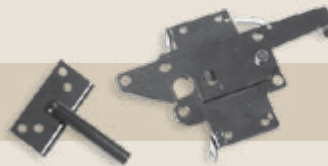

HLSS
STAINLESS STEEL
HATCHET LATCH
(Black, White, or Bronze)



V21SS
STAINLESS STEEL GRAVITY
LATCH W/PLATE
(Black, White, or Bronze)



V21LL
GRAVITY LATCH
KEYED 2-SIDES
(Black or White)

Misc.



DRAS OR DRAS48
24" OR 48" DROP ROD
(Black or White)
(Bronze Also for 24")



VGSH
GATE STOP/HANDLE COMBO
(Black or White)



VHDL
GATE HANDLE
(Black, White, or Bronze)



VGS
PVC GATE STOP
(Black or White)



CSB-12SS
STAINLESS STEEL SPRING CLOSER
(Black or White)

NOTE: Items on this page are not to scale.

COLOR OPTIONS

Classic Series

Looking for something
simple and timeless?

Check out your 4 Illusions
"Classic" color options.
White, Beige, Gray, and Clay.

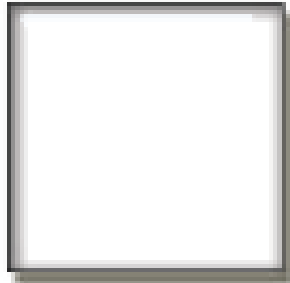

CLASSIC WHITE



CLASSIC BEIGE



CLASSIC GRAY

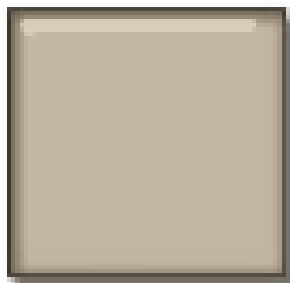

CLASSIC CLAY

ALL COLORS SHOWN ARE APPROXIMATE.
SEE PHYSICAL SAMPLE FOR ACTUAL COLOR.



QuickShip V300-6CL
6' Height Tongue and Groove
panels with 7/8" x 6" boards,
1-1/2" x 5-1/2" top and
bottom horizontal rails, a metal
reinforcement channel in the
bottom rail, and 7/8" x 1"
U-Channel edgings to add a
unique and attractive aesthetic.
Shown in the color Classic Clay.



All Classic Series Colors Are Available in V300-6 **QuickShip**[™]
For other styles and colors that are in stock all the time, just look for the **QuickShip** logo.

Fence Specifications



WHAT IS ASTM F964-13?

Scope

ASTM F964-13 is considered the “end all, beat all” testing specification for vinyl fence. The purpose of this specification is to establish a recognized standard of quality for exterior vinyl profiles for use in assembling agricultural, commercial, and residential fencing and railing. This specification covers Illusions Vinyl Fence sections and the EverStrong Profiles® used to fabricate them.

Materials

Illusions Vinyl Fence Products are manufactured using Rigid Poly Vinyl Chloride (PVC) compounds for exterior-profile extrusions that meet the requirements of ASTM Specification D4216.

Manufacture

Illusions Vinyl Fence Products are manufactured to meet cell Class 1–21333–22 as defined in Specification D4216. Illusions compounds have higher cell classification because one or more properties are superior to those used in standard acceptable compounds.

Color/Consistency Testing – The PVC compound in extruded section shall maintain uniform color and be free of any visual surface or structural changes, such as peeling, chipping, cracking, flaking, or pitting after weathering at intervals of six months and one year for white and for six months, one year, and two years for all other colors in hot, dry climate such as Phoenix, AZ; a hot humid climate, such as Miami, FL; and a temperate northern climate, when tested in accordance with ASTM Performance Weathering Requirements (TABLE 1).

Weathering Testing – The PVC compound shall have a minimum impact resistance of 0.6 in.-lb/mil (2670 J/m) after weathering six months and one year in a hot, dry climate such as Phoenix, AZ; a hot, humid climate, such as Miami, FL; and a temperate northern climate, when tested in accordance with ASTM Performance Weathering Requirements. The PVC compound shall have successfully met the weathering requirements prescribed for six months at each climatic testing site prior to use in production of exterior-profile extrusions, when tested in accordance with ASTM Performance Weathering Requirements (TABLE 1).

ASTM Specifications Met

- D256** - To determine Izod impact properties
- D618** – Practice for Conditioning Plastics for Testing
- D635** – Test Method for Rate of Burning and/or Extent and Time of Burning of Plastics in a Horizontal Position D638 - To determine tensile properties
- D648** - To determine heat distortion temperature
- D696** – Test Method for Coefficient of Linear Thermal Expansion of Plastics Between 030°C and 30°C with a Vitreous Silica Dilatometer
- D790** - To determine flexural properties
- D792** - To determine specific gravity
- D883** – Terminology Relating to Plastics
- D1435** – Practice for Outdoor Weathering of Plastics
- D1600** Terminology for Abbreviated Terms Relating to Plastics
- D1784** – Specification for Rigid Poly (Vinyl Chloride) (PVC) Compounds and Chlorinated Poly (Vinyl Chloride) (CPVC) Compounds
- D1898** – Practice for Sampling of Plastics
- D2240** - To determine Shore hardness values
- D2244** – Practice for Calculation of Color Tolerances and Color Differences from Instrumentally Measured Color Coordinates
- D2565** – Practice for Xenon-Arc Exposure of Plastics Intended for Outdoor Applications
- D4216** – Material Class Number 1–21333–22. To establish Cell Classification of PVC material. Illusions compounds have higher cell classification because one or more properties are superior to those used in standard acceptable compounds
- D4226** – Test Methods for Impact Resistance of Rigid Poly-(Vinyl Chloride) (PVC) Building Products
- D4726** – Specification for Rigid Poly(Vinyl Chloride) (PVC) Exterior-Profile Extrusions Used for Assembled Windows and Doors
- D7032** – Standard specification for establishing performance ratings for wood-plastic composite and plastic lumber deck boards, stair treads, guards, and handrails.
- E-84-04** - Used to determine the flame spread value of PVC material; Illusions burn rate is significantly lower than allowed value

Quality Assurance

Illusions Vinyl Fence Products are run through dimensional tests at the startup of a production run and every two hours thereafter including flattening, extrusion quality, impact resistance, warp, color comparison with standard color samples, capstock thickness, and bond testing will be done at the startup of a production and once per shift thereafter with a minimum of two tests per 24 hours of production.

TABLE 1 - Required Exposures for PVC Extrusions - In Process

Color of PVC Extrusions	Exposure Climate	Required Exposure Times, Months*
White	hot, dry (Phoenix, AZ)	6 and 12
	hot, humid (Miami, FL)	6 and 12
	northern temperate	6 and 12
Any other color	hot, dry (Phoenix, AZ)	6, 12 and 24
	hot, humid (Miami, FL)	6, 12 and 24
	northern temperate	6, 12 and 24

*It is recommended that separate specimens be used for each exposure time.

THESE ARE THE RESULTS FROM AN ACCELERATED WEATHER TESTING CHAMBER IN LABORATORY CONDITIONS

The Illusions® Vinyl Fence Advantage

This test is run according to ASTM Standard G-155, Cycle #1. All Illusions® Vinyl Fence Product is guaranteed to be made from 100% Pure Virgin Vinyl and assembled according to ASTM F964. Please note the difference in color retention and be assured, Illusions® Vinyl Fence will have uniformed color and be free of any visual surface or structural changes such as: peeling, chipping, cracking, flaking, or pitting after weathering.

Be assured! Insist on *Illusions® Vinyl Fence* Products.



Competitor:
450 Hrs.
(4-5 Years)



WOW!
THAT WOULD
COST A FORTUNE
IN RE-INSTALLS!



Illusions®:
1000 Hrs.
(10-11 Years)

Need Vinyl Railing Too?

Looking for the perfect railing to match your brand new Illusions Vinyl Fence?

From the tallest skyscraper to your front porch, ICC-ES AC174 compliant Illusions Vinyl Railing System is the perfect choice for your next railing installation. Made of 100% Pure Virgin Vinyl, all styles are available in all Classic Color options.

(Ask your local Illusions dealer for the Illusions Vinyl Railing brochure to find out more.)



www.illusionsvinylrailing.com

www.illusionsfence.com



Illusions[®]

Vinyl Fence

www.illusionsfence.com



- Beautify Your Outdoor Living Space
- Enjoy Stylish Privacy & Security
- Increase Your Property Value
- 100% Pure Virgin Vinyl - Fence
- Available in all Classic Color options



www.illusionsfence.com

Illusions products are sold wholesale to the trade.
Contact your local fence company for pricing.



Professional Fence Dealer