



274 Middle Island Rd.
Medford, NY 11763

1-631-698-0900
1-800-339-3362
Fax# 1-631-698-6408
www.easternfence.com

RESIDENTIAL GATE FRAMES
MADE WITH 17 GA - .055 DOMESTIC PIPE

Item No.	Size	Loose	10-49	50-199	200 or More
GF33	3' x 36" HIGH				
GF342	3' x 42"				
GF34	3' x 48"				
GF35	3' x 60"				
GF36	3' x 72"				
GF423	42" x 36"				
GF4242	42" x 42"				
GF424	42" x 48"				
GF425	42" x 60"				
GF426	42" x 72"				
GF43	4' x 36"				
GF442	4' x 42"				
GF44	4' x 48"				
GF45	4' x 60"				
GF46	4' x 72"				
DD104	10' x 4'				
DD105	10' x 5'				
DD106	10' x 6'				
DD124	12' x 4'				
DD125	12' x 5'				
DD126	12' x 6'				

NO SCROLLS ON 5' AND 6' HIGH GATES BUT THEY ARE CENTER BRACED.

**SPECIAL SIZE FRAMES - SET UP CHARGE AT \$
QUOTED FROM NEXT LARGEST SIZE**

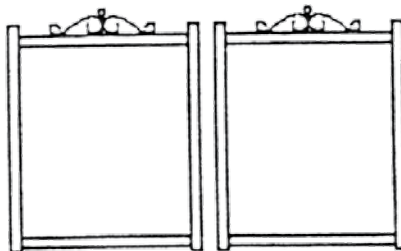

04/01/12



“WHEN IT COMES TO QUALITY, SERVICE AND PRICE, NO ONE DOES IT BETTER”



274 Middle Island Rd.
Medford, NY 11763

1-631-698-0900
1-800-339-3362
Fax# 1-631-698-6408
www.easternfence.com

KENNELS/ENCLOSURES

FRAMES: 1-3/8" O.D. galv. tubing

FABRIC: 2-1/4" mesh, 11-1/2" Gauge
Smooth Galvanized Wire

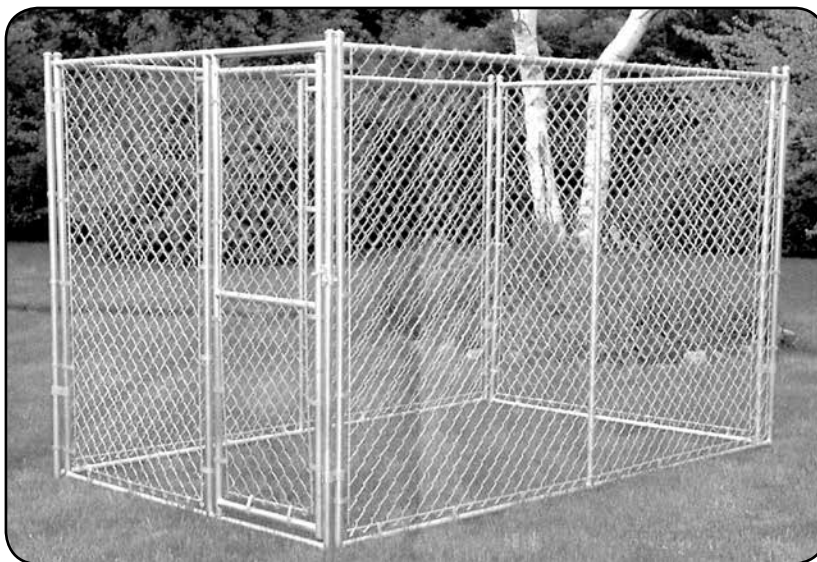

PANELS

6' HIGH				5' HIGH				4' HIGH			
W/O GATE		WITH GATE		W/O GATE		WITH GATE		W/O GATE		WITH GATE	
ITEM	COST	ITEM	COST	ITEM	COST	ITEM	COST	ITEM	COST	ITEM	COST
3'	KP36	KGP36		KP35		KGP35		KP34		KGP34	
4'	KP46	KGP46		KP45		KGP45		KP44		KGP44	
5'	KP56	KGP56		KP55		KGP55		KP54		KGP54	
6'	KP66	KGP66		KP65		KGP65		KP64		KGP64	
8'	KP86	KGP86		KP85		KGP85		KP84		KGP84	
10'	KP106	KGP106		KP105		KGP105		KP104		KGP104	
12'	KP126	KGP126		KP125		KGP125		KP124		KGP124	
14'	KP146	KGP146		KP145		KGP145		KP144		KGP144	

OPTIONS/ACCESSORIES:

- 9 gauge, 2" mesh, Vinyl-clad fabric Add 15%
- 9 gauge, 2" mesh, Galvanized fabric Add 20%
- Puppy, snow, or hesitation panel Add \$
- Dog house openings Add \$
- ADC138 Alum-Dome Cap (Need 9) \$
- SC138 Saddle Clamp. (Need 8)

COMPETE KENNELS/ENCLOSURES

- 6'H - 6'W - 10'L \$
- 6'H - 6'W - 12'L \$



04/01/12

“WHEN IT COMES TO QUALITY, SERVICE AND PRICE, NO ONE DOES IT BETTER”



274 Middle Island Rd.
Medford, NY 11763

1-631-698-0900
1-800-339-3362
Fax# 1-631-698-6408
www.easternfence.com

WELDED INDUSTRIAL SWING GATE FRAMES

SINGLE WALK GATES

Height	1-5/8" SS20 FRAME				2" SS20 FRAME			
	5'	6'	7'	8'	6'	7'	8'	10'
36" Opening								
42" Opening								
48" Opening								
60" Opening								

DOUBLE DRIVE GATES

Height	1-5/8" SS20 FRAME				2" SS20 FRAME			
	5'	6'	7'	8'	6'	7'	8'	10'
10' Opening								
12' Opening								
14' Opening								
16' Opening								
18' Opening*								
20' Opening*								
22' Opening*								
24' Opening*								
26' Opening**								
28' Opening**								
30' Opening**								

PER FOOT EXTRA ADDED TO WIDTHS:

1-5/8" = \$

2" = \$

FRAME CONFIGURATIONS

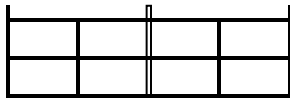

* 18' Double Leaf Gate

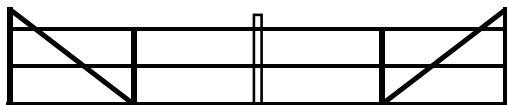

** 26' Double Leaf Gate - "k" Braced

SWING GATE RECOMMENDED POST SIZES

	MAXIMUM SINGLE	MAXIMUM DOUBLE
3" O.D.	6'	12'
4" O.D.	13'	26'
6-5/8" O.D.	18'	36'
8-5/8" O.D.	18' UP	36' UP

Overhead Slide Gates See Page C20 & 21

04/01/12

D3

“WHEN IT COMES TO QUALITY, SERVICE AND PRICE, NO ONE DOES IT BETTER”



274 Middle Island Rd.
Medford, NY 11763

1-631-698-0900
1-800-339-3362
Fax# 1-631-698-6408
www.easternfence.com



INTERNAL SLIDE GATE

Eastern cantilever slide gates are custom made to fit your opening. There are 2 parts of a cantilever gate. The part which covers the opening and the back section called the counter balance, which is a minimum 40% of the opening, i.e., a 20' opening has a minimum of an 8' counterbalance.

The track of your *Eastern* gate and the member of the gate frame are a one piece aluminum extrusion. There are no bolts on the tracks. All other members of the frame are welded to the top member. Unlike some similar gates that bolt together, your *Eastern* gate will be trouble free for many years.

Because the track is at the top, there are no ground rollers. There are guide rollers on the post that keep the bottom of the gate from swaying.

The top roller assemblies each have 4 factory lubricated and sealed roller bearing wheels that operate inside the track. Because they are inside the track, they are unaffected by ice, snow, dirt or other debris.

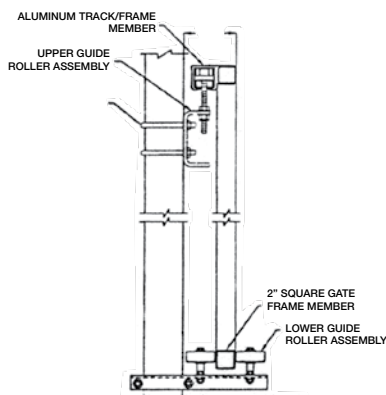

End View
Upper & Lower Guide
Roller Assembly
Attached to Post

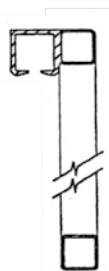

Single Track
Single Gate
3'-0" to 22'-0"

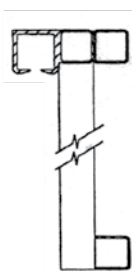

Single Track
Single Gate
Strengthened
23'-0" to 30'-0"

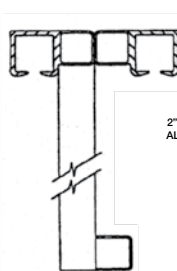

Dual Track
Single Gate
31'-0" to 40'-0"

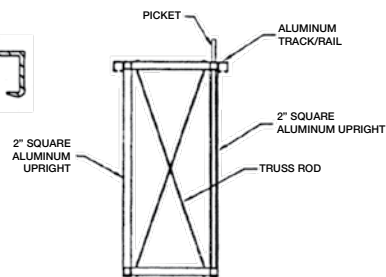

Box Frame
41'-0" to 50'-0"

FEATURES:

A FRAME FOR EVERY SIZE OPENING

D4

GATES MAY BE MANUALLY OR ELECTRICALLY OPERATED

04/01/12

“WHEN IT COMES TO QUALITY, SERVICE AND PRICE, NO ONE DOES IT BETTER”



274 Middle Island Rd.
Medford, NY 11763

1-631-698-0900
1-800-339-3362
Fax# 1-631-698-6408
www.easternfence.com

CANTILEVER SLIDE GATES

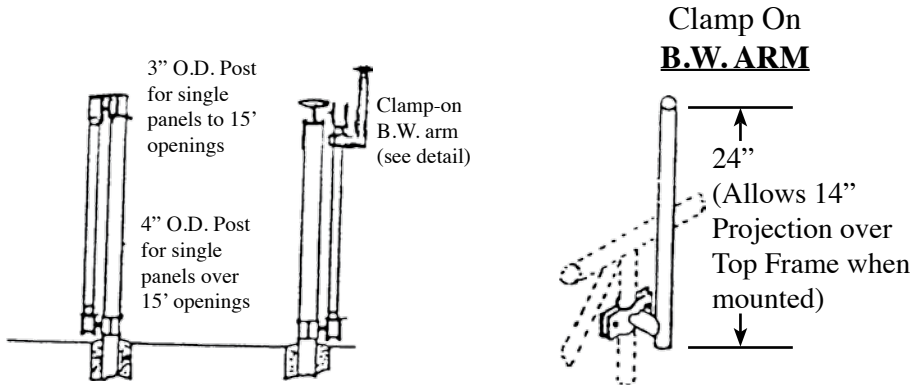

SIDE VIEW – TYPICAL POST ROLLER

Notes

1. Top/Bottom frame Members to be 2-1/2 O.D.
2. Vertical Frame Members to be 2" O.D.
3. Diagonal/Horizontal Members to be 1-5/8" O.D.

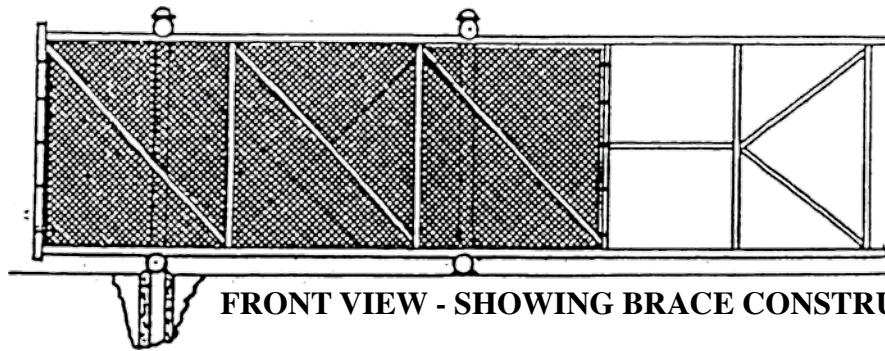

FRONT VIEW - SHOWING BRACE CONSTRUCTION

NOMINAL FENCE
HEIGHT MINUS 6"
(FOR BOTTOM ROLLER
CLEARANCE)

Gates 20' and over use
nylon rollers.

GATE OPENING
UP THRU 12'
OVER 12' THRU 24'

SUPPORT PANEL LENGTH
5' TO 6'
1/2 OF GATE OPENING

HEIGHT	OPENING LENGTH	PRICE
4'0 - 14'	10' - 40'	CALL FOR QUOTE

NOTE: OVER 26' OPENING REQUIRES OUTRIGGER TO BE FIELD INSTALLED

04/01/12



“WHEN IT COMES TO QUALITY, SERVICE AND PRICE, NO ONE DOES IT BETTER”



274 Middle Island Rd.
Medford, NY 11763

1-631-698-0900
1-800-339-3362
Fax# 1-631-698-6408
www.easternfence.com

CANTILEVER GATE SAFETY RECOMMENDATIONS

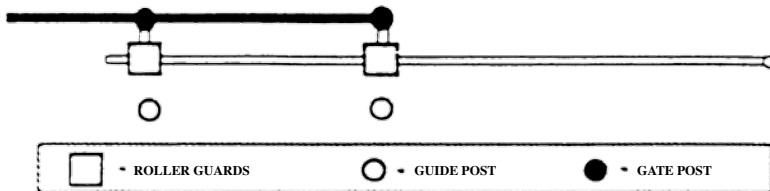

ASTM F 1184-93

REQUIRES GUIDE POSTS AND ROLLER GUARDS ON EXTERNAL ROLLER CANTILEVER SLIDE GATES

MUST ORDER WITH EACH ROLLER

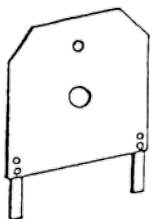

BOTTOM PROTECTIVE PLATE

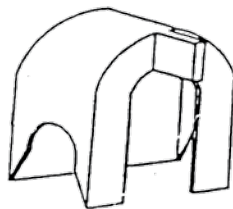

TOP ROLLER GUARD

SAFETY EDGES ARE RECOMMENDED WHEN USED WITH GATE OPERATORS

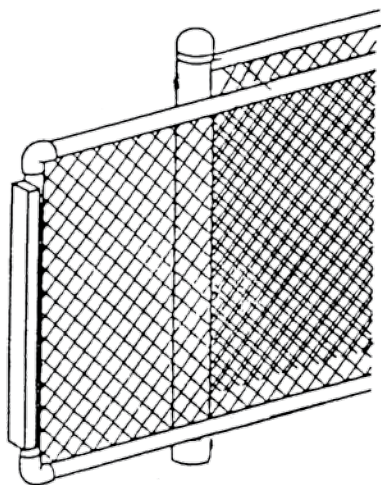

INTERNAL SLIDE GATES

Vertical post placed on both sides of the exposed rollers can prevent hands from reaching these pinch points. Safety edges placed on these posts can be wired to stop the unit upon contact.

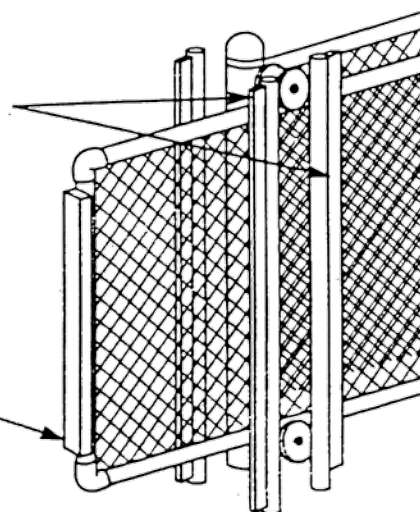

EXTERNAL SLIDE GATES

D6

04/01/12

“WHEN IT COMES TO QUALITY, SERVICE AND PRICE, NO ONE DOES IT BETTER”



274 Middle Island Rd.
Medford, NY 11763

1-631-698-0900
1-800-339-3362
Fax# 1-631-698-6408
www.easternfence.com

ROLLING GATE FRAMES

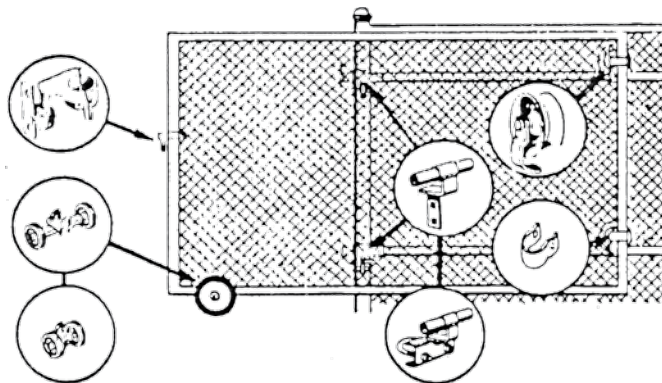

FRAME CONFIGURATION

OPENING SIZES

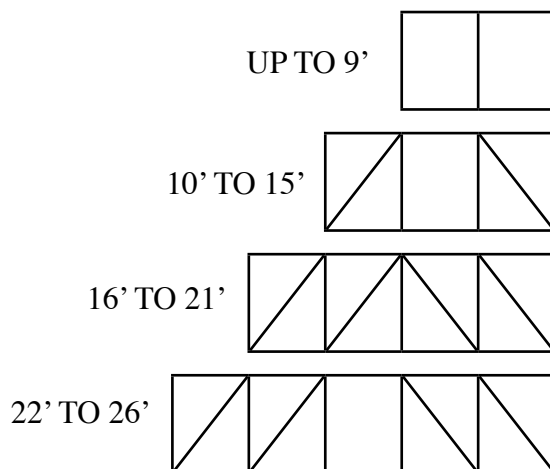

NOTES:

1. MADE WITH 1-5/8" SS20 PIPE AND 1-3/8" RES BRACING
2. GATES ALSO AVAILABLE IN HEAVIER PIPE.
3. GATES AVAILABLE OVER 26' LENGTH
4. ROLLING GATE HARDWARE – SEE PAGE C14 & C15

GATES PRICES — CALL FOR QUOTE

274 Middle Island Rd.
Medford, NY 11763



1-631-698-0900
1-800-339-3362
Fax# 1-631-698-6408
www.easternfence.com

SPECIALTY FABRICATION

FARM GATES

BARRIER GATES

BI-FOLD GATES

PIPE BENDING

WELDED FLANGES

PIPE RAILING JOBS

PRE-FAB PANELS

CUSTOM STORAGE PARTITIONS

Tell us what you need, and we will do it!

D8

04/01/12

“WHEN IT COMES TO QUALITY, SERVICE AND PRICE, NO ONE DOES IT BETTER”