



## ADA Compliant Hand Rail Secure-Mount Post System

**INSTALLATION & MAINTENANCE GUIDE**

JANUARY 2013



decking | railing | lighting | fastening | fencing

[timbertech.com](http://timbertech.com)

# Dear Valued Customer:



**TimberTech would like to thank you for your interest in our railing systems. We strive to better serve our customers and hope that you have a wonderful experience with TimberTech.**

TimberTech focuses on quality, innovation and brand in all that we do. With an assortment of plank profiles, industry leading railing systems, fencing and numerous accessories, building beautiful decks has never been easier.

TimberTech is committed to providing builders and professional deck installers with exciting new products our customers demand, as well as programs and support material to differentiate themselves in the marketplace.

TimberTech has compiled this Railing & DeckLites® Installation & Maintenance Guide to provide a thorough resource for technical information for our railing systems and deck lighting system.

To get information on other TimberTech products visit [timbertech.com](http://timbertech.com) or ask your dealer for these installation guides:

- **TimberTech Decking & DrySpace™ Installation & Maintenance Guide**
- **TimberTech FenceScope® Installation & Maintenance Guide**

## Installing TimberTech

**TimberTech offers a variety of innovative railing systems and infill options. A variety of color choices allow you to match or complement your TimberTech deck planks.**

TimberTech products are a revolutionary alternative to traditional wood—they don't rot, warp or splinter—and they look great year after year. And unlike wood, TimberTech products require no painting, staining or sealing.

**Make sure your project meets local building codes before you begin installation.**

These installation guidelines will direct you through the process of installing TimberTech railing systems. These methods are recommended by TimberTech but may not cover every installation scenario you encounter. Since each installation is unique in its performance requirements, the ultimate installation method used is the sole responsibility of the installer. TimberTech recommends that all designs be reviewed by a licensed architect, engineer or local building official before installation.

### TimberTech Code Listings

Once a product is tested by an independent lab, an application and report is submitted to one of several agencies that provide listings for building products that meet the requirements of Acceptance Criteria 174 (AC 174) as set forth by the International Code Council Evaluation Service (ICC-ES). TimberTech currently has listings from the ICC-ES and Architectural Testing Inc. The following TimberTech reports on code compliance are available to download on [www.timbertech.com](http://www.timbertech.com).

**For the most up-to-date code listings visit**

**[www.timbertech.com/installation](http://www.timbertech.com/installation).**

#### ICC Evaluation Service, Inc.

ICC ESR-1400 • Ornamental Rail System



#### Underwriters Laboratories, Inc.

E351168 • DeckLites

#### ATI Architectural Testing, Inc.

CCRR-0114 • RadianceRail

CCRR-0129 • BuilderRail

Code listing for RadianceRail Express Pending

#### Test Reports:

ADA Hand Rail & Secure Mount Post System tested to requirements of ICC-ES-AC-174

# Railing Product Choices











RAILING & RAILING ACCESSORIES	Size	Color/Finish										
		Cedar	Grey	Redwood	Antique White	Classic Black	Coastal White	Mountain Cedar	RiverRock	SandRidge	Traditional Walnut	Brick
<b>RADIANCE RAIL®</b>												
6' RadianceRail Complete Kit-Square Balusters	6' length - 36" high					X	X					
8' RadianceRail Complete Kit-Square Balusters	8' length - 36" high					X	X					
6' RadianceRail Rail Pack	6' length				X	X						
8' RadianceRail Rail Pack	8' length				X	X						
8' RadianceRail Custom Rail Pack (no pre-drilled holes)	8' length				X	X	X	X	X	X	X	X
6' Baluster Pack - Square Balusters	6' length, 36" high / 42" high				X	X	X	X	X	X	X	X
8' Baluster Pack - Square Balusters	8' length, 36" high / 42" high				X	X	X	X	X	X	X	X
Hardware Mounting Kit	N/A											
Post Cover for 4x4 Post (use with 36" rails)	5" x 5" x 42"				X	X	X	X	X	X	X	X
Post Cover for 4x4 Post (use with 42" rails)	5" x 5" x 12"				X	X	X	X	X	X	X	X
Post Cap and Post Skirt	N/A				X	X	X	X	X	X	X	X
<b>RADIANCE RAIL® EXPRESS</b>												
6' RadianceRail Express Rail Pack	6' length					X	X					X
8' RadianceRail Express Rail Pack	8' length					X	X					X
8' RadianceRail Express Stair Rail Pack	8' length					X	X					X
6' Baluster Pack Square Balusters	6' length, 36" high / 42" high					X	X					X
8' Baluster Pack Square Balusters	8' length, 36" high / 42" high					X	X					X
Post cover for 4x4 Post (use with 36" rails)	4"x4" x 39"					X	X					X
Post cover for 4x4 Post (use with 42" rails)	4"x4" x 8"					X	X					X
Hardware Mounting Kit	N/A					X	X					X
Hardware Mounting Kit for stairs	N/A					X	X					X
Gasket Pack	N/A					X	X					X
Post Cap and Post Skirt	N/A					X	X					X
<b>EVOLUTIONS RAIL®   CONTEMPORARY</b>												
16' Evolutions Rail   Contemporary Top Rail	16' length					X						X
6' Evolutions Rail   Contemporary Rail Pack	6' length					X						X
8' Evolutions Rail   Contemporary Rail Pack	8' length					X						X
6' Baluster Pack - Square Balusters	36" high / 42" high					X						X
8' Baluster Pack - Square Balusters	36" high / 42" high					X						X
Hardware Kit	N/A					X						X
Post Cover for 4x4 Post (for 36" rail)	5 x 5 x 42"					X						X
Post Cover for 4x4 Post (for 42" rail)	5 x 5 x 8"					X						X
Post Skirt	N/A					X						X
<b>EVOLUTIONS RAIL®   BUILDER</b>												
6' Evolutions Rail BuilderBoard	6' length					X						X
8' Evolutions Rail BuilderBoard	8' length					X						X
Metal Baluster Pack - Black	8' length, 36" high / 42" high					X						X
Metal Baluster Pack for Stairs - Black	8' length, 36" high / 42" high					X						X
Hardware Kit	N/A					X						X
Post Cover for 4x4 Post (for 36" rail)	5 x 5 x 42"					X						X
Post Cover for 4x4 Post (for 42" rail)	5 x 5 x 8"					X						X
Post Skirt	N/A					X						X
<b>ORNAMENTAL RAIL</b>												
6' Ornamental Rail Kit:	6' length	X	X	X								
8' Ornamental Rail Kit:	8' length	X	X	X								
6' Baluster Kit, 16 Pre-Cut Solid Square, 36" rail ht.	1.3" x 1.3" x 27"	X	X	X								
8' Baluster Kit, 20 Pre-Cut Solid Square, 36" rail ht.	1.3" x 1.3" x 27"	X	X	X								
4' Post Cover for 4x4 Post	4.25" x 4.25" x 4"	X	X	X								
12' Post Cover for 4x4 Post	4.25" x 4.25" x 12"	X	X	X								
Baluster, Solid Square	1.3" x 1.3" x 12"	X	X	X								
Post Cap and Post Skirt	N/A	X	X	X								
<b>BUILDER RAIL®</b>												
6' BuilderRail Kit: Black Classic Metal Balusters	6' length, 36" high / 42" high											
8' BuilderRail Kit: Black Classic Metal Balusters	8' length, 36" high / 42" high											
8' BuilderRail Stair Kit: Black Classic Metal Balusters	8' length, 36" high / 42" high											
BuilderRail Post Brackets - Black	90°											
BuilderRail Stair Post Brackets - Black	125°											
BuilderBoard® Rails	6' or 8' lengths	X	X	X								
Post Skirt	N/A	X	X	X								
Foot Blocks		X	X	X								
<b>* Use Ornamental Rail Post Covers and Post Skirts with BuilderRail.</b>												
<b>METAL BALUSTERS</b>												
Metal Baluster Pack - Black	8' length, 36" high / 42" high											
Metal Baluster Pack for Stairs - Black	8' length, 36" high / 42" high											
<b>* Use with RadianceRail® and Evolutions Rail™</b>												
<b>CABLERAIL by FEENEY</b>												
Quick-Connect® Hardware Packs	36" high (9 connectors) / 42" high (11 connectors)											
Cable	100' spool and 500' rolls											
CableRail Accessory Pack	N/A											
<b>* Use with RadianceRail® and Evolutions Rail™.</b>												
<b>ADA HAND RAIL SYSTEM</b>												
Grab Rail with Aluminum Insert	1.5" OD x 104"						X	X				
Aluminum Joiner Kit	1" OD x 6"											
Inside/Outside Corner	1-1/2" OD x 4" x 4"						X	X				
Inline Wall Mount Bracket	3"						X	X				
Inside Corner 90° Standoff Bracket	6-1/4"						X	X				
End Cap	1-1/2"						X	X				
Handicap Loop	18" x 12" x 18"						X	X				
Adjustable Internal Joiner												
90° Return Bracket	3.75" x 3.5"						X	X				
External Swivel Connector							X	X				
Standoff Bracket	2-1/4"						X	X				
<b>SECURE-MOUNT POST SYSTEM</b>												
Secure-Mount Post	36" - Adjusts to 42" high if needed											
Deck Mounting Kit (includes leveling kit)	N/A											

# ADA Compliant Hand Rail System

- Consult your local building codes for guard and handrail requirements.

TimberTech's ADA Hand Rail System conforms to the requirements of the American with Disabilities Act (ADA) - it provides a continuous gripping surface through its entire length. It is designed to be an aesthetically pleasing complement to TimberTech's Railing Systems and is easy to install.

## Components Needed For Installing One ADA Hand Rail System:

- |           |  |   |                      |
|-----------|--|---|----------------------|
| <b>1</b>  | 104" Grab Rail with aluminum insert<br>1.5"OD x 104"     |    | ADA104W<br>ADA104B   |
| <b>2</b>  | Aluminum Joiner Kit<br>1"OD x 6"                         |    | ADAJKT               |
| <b>3</b>  | 4" x 4" 90° Inside/Outside Corner<br>1-1/2" OD x 4" x 4" |    | ADAOSCW<br>ADAOSCB   |
| <b>4</b>  | Inline Wall Mount Bracket<br>3"                          |    | ADAIWBW<br>ADAIWBB   |
| <b>5</b>  | Inside Corner 90° Standoff Bracket<br>6-1/4"             |  | ADAINCW<br>ADAINCB   |
| <b>6</b>  | End Cap<br>1-1/2"  |  | ADAECAPW<br>ADAECAPB |
| <b>7</b>  | Handicap Loop<br>18" x 12" x 18"                         |  | ADAHDLW<br>ADAHDLB   |
| <b>8</b>  | Adjustable Internal Joiner                               |  | ADAADJ               |
| <b>9</b>  | 90° Return Bracket<br>3.75" x 3.5"                       |  | ADA90RBW<br>ADA90RBB |
| <b>10</b> | External Swivel Connector                                |  | ADAEXTW<br>ADAEXTB   |
| <b>11</b> | Standoff Bracket<br>2-1/4"                               |  | ADASOBW<br>ADASOBB   |

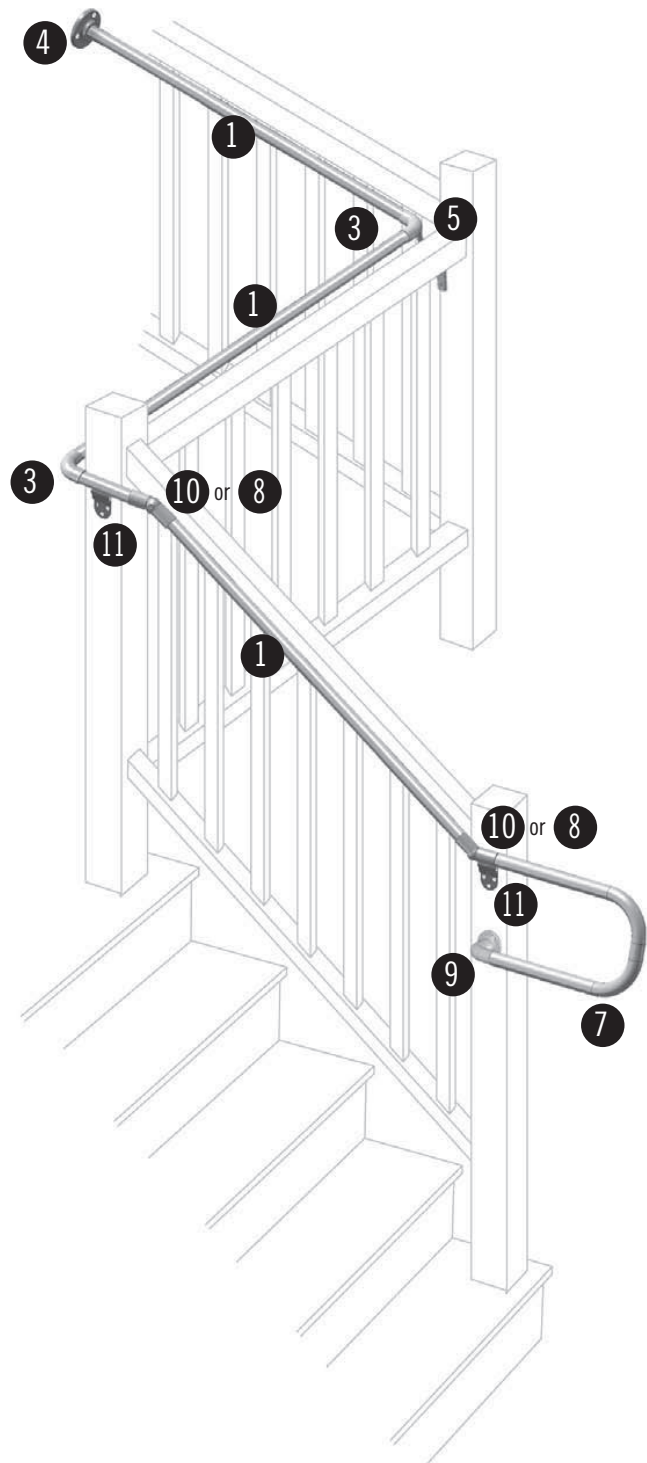

## Handicap Loop

### Used at the Bottom of Steps or Handicap Ramps

- Attach top bracket at desired location using appropriate connectors.
- Cut Handicap Loop to desired length.
- Connect Handicap Loop to ADA tube using the appropriate connector (Aluminum Joiner or Adjustable Internal Joiner.)
- Set Handicap Loop on top bracket, pre-drill with drill bit and install self-tapping screw provided.
- Install desired lower bracket.

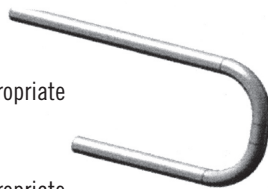

## Adjustable Internal Joiner – 0 to 90°

### Used for Angles

- Miter Cut ADA Grab Rail with aluminum insert to desired length.
- Install Adjustable Internal Joiner inside both ends of the tube.
- Pre-drill 90° Corner and Straight Joiner with drill bit, and install self tapping screw provided.



## 90° Return Bracket

### Used for Both Post and Wall Returns

- Cut ADA Grab Rail tube with aluminum insert to desired length.
- Insert 90° bracket into the ADA tube.
- Install counter sunk screws provided through the bracket.
- Pre-drill aluminum reinforced tube and bracket with drill bit, and install self-tapping screw provided.



## Inline Wall Mount

### Used for Straight Wall Connections

- Cut ADA Grab Rail tube with aluminum insert to desired length.
- Insert 90° bracket into the ADA tube.
- Install counter sunk screws provided through the bracket.
- Pre-drill aluminum reinforced tube and bracket with drill bit, and install self-tapping screw provided.

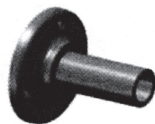

## Standoff Bracket

### Used for Rail Applications on Walls or Posts

- Install counter sunk screws provided through the bracket into the mounting surface.
- Place rail at appropriate location on the bracket.
- Pre-drill aluminum reinforced ADA tube with drill bit, and install self-tapping screw provided.
- Place End Cap on rail.



## Aluminum Joiner Kit

### Used to Connect Two ADA Tubes or 90° Corner Brackets

- Cut ADA Grab Rail tube with aluminum insert to desired length.
- Pre-drill aluminum reinforced ADA tube and joiner with drill bit, and install self-tapping screw provided.

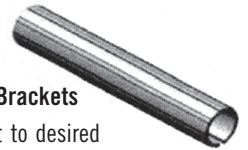

## External Swivel Connector – 0 to 60°

### Used for Step Angles

- Adjust External Swivel to desired angle and install set screw.
- Cut ADA Grab Rail Tube with aluminum insert to desired length.
- Insert External Swivel bracket into the ADA tube.
- Pre-drill aluminum-reinforced ADA Grab Rail Tube and bracket with drill bit, and install self-tapping screw provided.



## Inside/Outside Corner – 90°

### Used for Inside and Outside Corners

- Install two Straight Joiners into the 90° Corner.
- Pre-drill 90° Corner and Straight Joiner with drill bit and install self-tapping screw provided.
- Cut ADA Grab Rail tube with aluminum insert to desired length.
- Pre-drill aluminum reinforced tube and bracket with drill bit, and install self-tapping screw provided.



## Inside Corner Standoff Bracket – 90°

### Used with 90° Elbow for Inside Corner Applications

- Install counter sunk screws provided through the bracket into the mounting surface (corner of post.)
- Place 90° Corner at appropriate location on the bracket.
- Pre-drill 90° Corner with drill bit, and install self-tapping screw provided.



# Secure-Mount Post System and Deck Mounting Kit

Visit [www.timbertech.com/installation](http://www.timbertech.com/installation) to view TimberTech installation videos.

TimberTech's Secure-Mount Post and Deck Mounting Kit provide a solution for installing railing posts directly onto a deck or porch surface, without the use of a 4x4 treated post. The Secure-Mount Post is designed for use on composite decks, concrete surfaces and commercial areas.

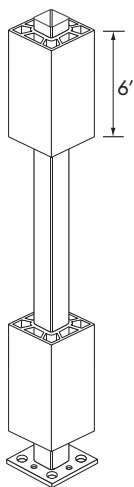

## Secure Mount Post

Includes 2 Leveling Shims for deck or concrete applications.

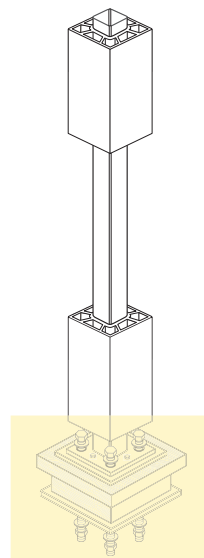

## Deck Mounting Kit

Includes Leveling Plate, Base Plate and Flange Mounting Hardware.

## Important Information

- It is the responsibility of the installer to meet all code and safety requirements and to obtain required building permits.
- Plumb post with level and shim between the deck and post-mount base plate with provided shims, if necessary.
- **For RadianceRail Applications: use the twelve #10 x 2" stainless steel screws that are included with the Secure Mount Post to replace the 3" green screws for the rail to post connection.**
- For mounting to concrete, additional mounting bolts must be purchased.

## Flange Deck Mount Applications (hardware included)

### • 36" x 6', 36" x 8' and 42" x 6' rail applications

Install TimberTech Secure-Mount Post with optional TimberTech Flange Deck Mounting Kit that includes Leveling Plate, Base Plate, and Flange Mounting Hardware.

### • 42" x 8' rail applications must use through bolt installation

Use 3/8 Hex head bolt, carriage bolt or threaded rod a minimum of 13" in length must be mounted through the bottom post mount block and deck (as shown). Installer should determine the correct length of the bolt needed. Hardware for this application is not included.

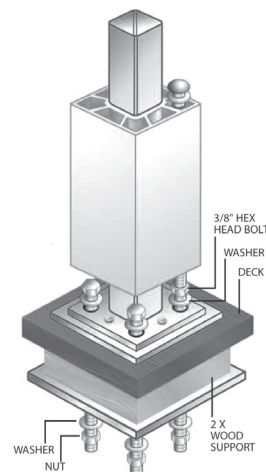

## Composite Applications (hardware included)

The Deck Mounting Kit includes a Leveling Plate, Base Plate and Flange Mounting Hardware for composite applications.

- Whether you are installing a 36" or 42" high railing section, the Secure-Mount Post provides the flexibility for proper attachment with its adjustable Top Mounting Block.
- The Secure-Mount Post comes packaged and set for a 36" high railing application.
- To use with a 42" Railing System, remove the 1-1/4" Set screw, located inside the top opening of the Top Attachment Block.
- Through bolt pattern for 42" x 8' installation.

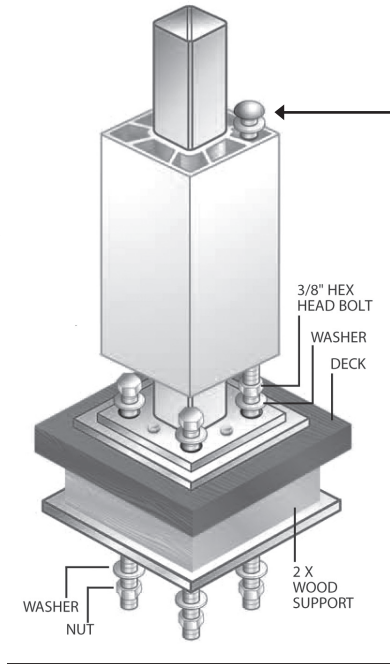

Once the set screw is removed, slide the Top Attachment Block up approximately 6" and align the bottom opening with the pre-drilled hole of the internal support post. Securely fasten the 1-1/4" set screw and you are ready for the 42" installation.

### 1 Determine Post Location

Placement of the Secure-Mount Post should be measured with a center-to-center measurement of 72" when installing a 6' rail section and 96" when installing an 8' rail section.

### 2 Install Blocking

Once you have determined the layout for the Secure-Mount Posts on the deck's substructure, you will need to install blocking between the designated joists.

**A** - Using a doubled 2x12 as the block, secure the block in the joist bay and attach on at least three sides.

- At least a #8 x 3" stainless steel or high-quality coated exterior wood screw for the block attachment is recommended and approved for use in treated lumber.
- Staggering 3" screws is recommended.

**B** - Note that the wood grain of the 2x12 block must be installed perpendicular to the outside rim joist of the deck.

- Installation of a perpendicular joist block will be needed to ensure attachment on all three sides of the blocking.

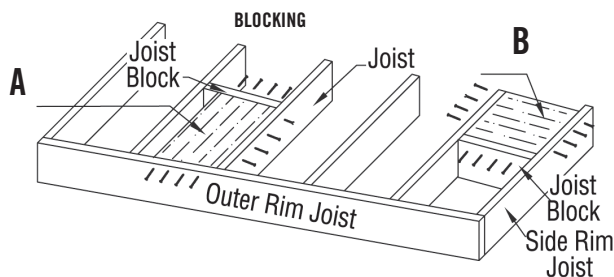

### 3 Attach Post

Once the TimberTech decking has been installed and the blocking is in place, use the base plate of the Secure-Mount Post as a template and mark the four corner holes for the 3/8" x 5-1/2" Hex Head Bolts.

- Drill four 7/16" holes through the marked holes, drilling through the deck plank and the reinforcement blocking below.
- Align the base plate over the drilled holes.
- Take the Secure-Mount Post and place it on the base plate lining up the holes.
- Screw the 5/16" leveling set screws into the four tapped holes.
- Insert the four 3/8" x 5-1/2" bolts into the drilled 7/16" holes.
- Take the bottom plate and line it up with the bolts under the TimberTech deck plank and the 2x12 support blocking.
- Install the washer and securely tighten with the included nut on all four 3/8" bolts.
- If needed, adjust the leveling set screws to plumb the Secure Mount Post.
- For corner post installations, use the off-set holes of the base plate.

Once the Secure-Mount Post is securely attached, trim the TimberTech Post Cover to the desired height and slide it over the post to begin rail section installation.

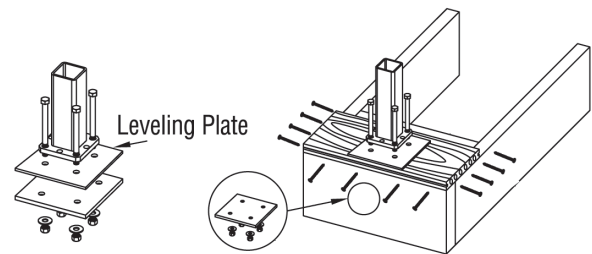

## Concrete Mount Applications

(hardware NOT included)

- **36" x 6', 36" x 8' and 42" x 6' rail applications**  
Install using Flange Mounted TimberTech Secure Mount Post.
- **42" x 8' rail applications**  
Install through bolt (hardware NOT included).
- 3/8" Diameter Wedge Anchor recommended for concrete applications.
- Through bolt pattern for 42" x 8' installation.

Threaded rod would only be needed for 42" x 8' rail application and is not included. Threaded rod in a through bolt application on concrete would need to be used with an anchoring adhesive.

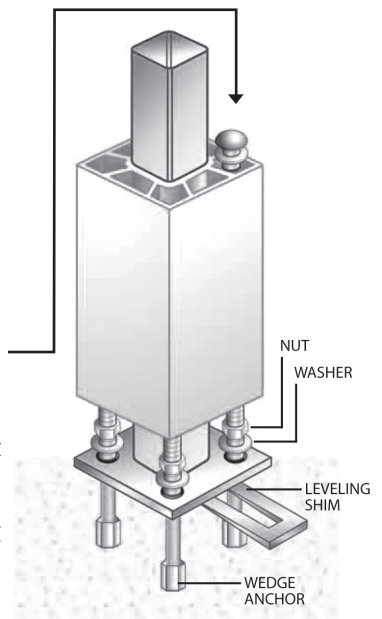

# Care & Cleaning

With proper installation and care, TimberTech products will provide years of outdoor living pleasure.

## Storage

Store TimberTech products under cover to maintain a clean surface. If stored outdoors, they must be covered with a non-translucent material.

- All products should be stored flat and on a dry surface.
- Stack units with banding and bottom supports aligned.

## Discarding Scrap Product

Scrap can be discarded with normal construction debris.

## Care & Cleaning

### Basic Cleaning Recommendations

Although TimberTech products are low-maintenance, TimberTech recommends periodic cleaning to help maintain the beauty of the product. For best results a cleaner like eco-friendly Corte Clean ([corteclean.com](http://corteclean.com)) is recommended. Follow the manufacturers' application instructions.

A power washer can be used when cleaning your TimberTech products. The recommended maximum pressure is 1500psi. A fan tip nozzle should be used along with the proper cleaning product. Spray in the direction of the brush/grain pattern to avoid damaging the product. Use caution not to damage the material and always take the proper safety precautions when operating a power washer.

### Ice and Snow

For ice removal, either rock salt or calcium chloride may be used without damage to the surface. However, either of these products may leave a white residue, which may be removed by either rinsing with water, or a mild soap/water solution.

### Dirt, Grime, Tannin, and Mildew Stains

TimberTech products are formulated to inhibit mildew growth and minimize staining. Rinse off your TimberTech products periodically with a hose. Even if it appears clean, it is important to prevent build-up of pollen/debris. Mildew stains may occur where moisture, pollens, and/or dirt are present. Mildew needs a food source to grow, which can be grass, pollens, dirt, debris, wood and wood resins.

Cleaners that are recommended for use with TimberTech are:

- Sun Frog Composite Deck Cleaner ([sunfrog.com](http://sunfrog.com))
- Super Deck Composite Deck Cleaner ([superdeck.com](http://superdeck.com))
- Corte Clean ([corteclean.com](http://corteclean.com))
- E Z Off Composite Wood Cleaner ([sunbritesupply.com](http://sunbritesupply.com))
- Thompson's Water Seal—Oxy Action ([thompsonswaterseal.com](http://thompsonswaterseal.com))

### Spot Stains

Many stains can be cleaned with soap and water. If the stains have set, the following

cleaners have been found to remove or reduce the stains. Always follow the manufacturer's instructions to achieve maximum results. Areas cleaned may lighten; this will require 8-10 weeks exposure to the sun to match the remaining product.

### Ornamental Rail, and BuilderRail:

#### General Cleaning:

- Soap & Water
- CorteClean

#### Tree Sap:

- Krud Cutter ([krudcutter.com](http://krudcutter.com))
- Simple Green ([simplegreen.com](http://simplegreen.com))

#### Spray Paint:

- Lift Off #4 ([liftoffinc.com](http://liftoffinc.com))

#### Oil, Grease:

- Krud Cutter ([krudcutter.com](http://krudcutter.com))
- Oil Eater ([oileater.com](http://oileater.com))

#### BBQ, Ketchup, Mustard, Jelly and Jam:

- Krud Cutter ([krudcutter.com](http://krudcutter.com))

#### Wine:

- Wine Away ([wineaway.com](http://wineaway.com))

#### Kool-Aid:

- Oxi Clean ([oxiclean.com](http://oxiclean.com))

### RadianceRail & RadianceRail Express:

#### General Cleaning:

- Soap & Water
- CorteClean

#### Pencil marks or other scuffs:

- Mr. Clean Magic Eraser

### RadianceRail & RadianceRail Express Touch-Up:

Duplicolor 2-in-1 Automobile Touch-up Paint is recommended for scratches, nicks and scuffs on TimberTech RadianceRail:

- For Coastal White use "Gloss White"
- For Classic Black use "Universal Flat Black"

### Evolutions Rail:

#### General Cleaning:

- Soap & Water



# 25-Year Limited Residential Warranty 10-Year Limited Commercial Warranty



## Alternative decking materials, rail systems, accessories and the DrySpace deck drainage system

Statement of Warranty: This warranty is given to the original purchaser, residential or commercial as the case may be ("Purchaser"), of TimberTech alternative decking materials, rail systems (excluding all metal baluster components of such rail systems and DeckLites, which are covered under separate warranties), and accessories (individually and collectively "Decking Materials") and the DrySpace deck drainage system ("DrySpace" and, collectively with the Decking Materials, the "TimberTech Products"). This warranty does not extend to fasteners that are not supplied by TimberTech. For purposes of this warranty, a residential Purchaser shall refer to a single-family residential homeowner and a commercial Purchaser shall refer to any Purchaser other than a single-family residential homeowner.

TimberTech Limited ("TimberTech") warrants to Purchaser that, for a period of twenty-five (25) years (Residential) & ten (10) years (Commercial) from the date of the original purchase, residential or commercial as the case may be, (the "Term"), under normal use and service conditions, that: (1) the Decking Materials will be free from material defects in workmanship and materials, and will not check, split, splinter, rot or suffer structural damage from termites or fungal decay; and (2) DrySpace will not peel, blister, pit, flake, crack or corrode as a result of manufacturing defects, or as a result of exposure to ocean air (salt spray).

All warranties are subject to the exclusions, limitations and restrictions set forth below.

Obtaining Warranty Performance: If Purchaser discovers a defect in the TimberTech Products during the Term, Purchaser must, within thirty (30) days from the discovery of the alleged defect but no later than the end of the Term, notify TimberTech in writing, at the following address:

TimberTech Limited  
894 Prairie Avenue  
Wilmington, Ohio 45177  
Attn: Claims Department

Purchaser must include in this notification proof of purchase and a statement explaining the defect. TimberTech may request additional information. After reviewing all information, TimberTech will make a determination regarding the validity of such claim. If TimberTech determines that Purchaser's claim is valid, TimberTech will, at its option, either replace the defective TimberTech Products or refund the portion of the purchase price paid by Purchaser for such defective TimberTech Products (not including the cost of its initial installation).

If a residential Purchaser makes a valid warranty claim hereunder during years eleven (11) through twenty-five (25) after the original purchase, then the residential Purchaser's recovery will be prorated as indicated below. If TimberTech is providing replacement materials, it may elect to replace the percentage listed below of boards otherwise meeting the requirements for a claim; if TimberTech is refunding the purchase price, it may elect to refund the percentage listed below of the purchase price of boards otherwise meeting the requirements for a claim.

Year of Claim	Recovery
11	80%
12	80%
13	80%
14	60%
15	60%

Year of Claim	Recovery
16	60%
17	40%
18	40%
19	40%
20	20%

Year of Claim	Recovery
21	20%
22	20%
23	10%
24	10%
25	10%

This warranty shall not cover, and TimberTech shall not be responsible for, costs and expenses incurred with respect to the removal of the defective TimberTech Products or the installation of replacement materials, including but not limited to, labor and freight. The foregoing remedies are the SOLE AND EXCLUSIVE REMEDY FOR BREACH OF ANY WARRANTY.

Transfer of Warranty: This warranty may be transferred one (1) time, within the five (5) year period beginning from the date of original purchase by Purchaser, to a subsequent buyer of the property upon which the TimberTech Products were originally installed.

Exclusions from Warranty Coverage: TimberTech does not warrant against and is not responsible for, and no implied warranty shall be deemed to cover, any product failure, product malfunction, or damages attributable to: (1) improper installation of the TimberTech Products and/or failure to abide by TimberTech's installation guidelines, including but not limited to improper gapping; (2) use of TimberTech Products beyond normal use, or in an application not recommended by the TimberTech installation guidelines and local building codes; (3) movement, distortion, collapse or settling of the ground or the supporting structure on which the TimberTech Products are installed; (4) any act of God (such as flooding, hurricane, earthquake, lightning, etc.), environmental condition (such as air pollution, mold, mildew, etc.), or staining from foreign substances (such as dirt, grease, oil, etc.); (5) variations or changes in color of TimberTech Products; (6) normal weathering due to exposure to sunlight, weather and atmosphere which can cause colored surfaces to, among other things, flake, chalk, or accumulate dirt or stains; (7) improper handling, storage, abuse or neglect of the TimberTech Products by Purchaser, the transferee or third parties; (8) any fasteners not supplied by TimberTech; or (9) minor dripping from DrySpace.

Purchaser is solely responsible for determining the effectiveness, fitness, suitability and safety of the TimberTech Products in connection with their use in any particular application.

Limitations: DISCLAIMER OF WARRANTIES: EXCEPT FOR (1) THE EXPRESS WRITTEN WARRANTY CONTAINED HEREIN, AND, (2) THE 25 YEAR LIMITED RESIDENTIAL FADE AND STAIN WARRANTY APPLICABLE TO EARTHWOOD EVOLUTIONS DECKING ONLY (WHICH IS IN ADDITION TO THE WARRANTY CONTAINED HEREIN), TIMBERTECH MAKES NO OTHER WARRANTIES, GUARANTEES OR INDEMNITIES, WHETHER EXPRESS OR IMPLIED, ARISING BY LAW, COURSE OF DEALING, USAGE OF TRADE, CUSTOM OR OTHERWISE, INCLUDING BUT NOT LIMITED TO THE IMPLIED WARRANTY OF MERCHANTABILITY AND IMPLIED WARRANTY OF FITNESS FOR A PARTICULAR PURPOSE, AND ALL SUCH OTHER WARRANTIES, GUARANTEES AND INDEMNITIES ARE HEREBY DISCLAIMED, OVERRIDDEN AND EXCLUDED FROM THIS TRANSACTION FOR THE WARRANTY TERM AND BEYOND THE WARRANTY TERM.

Some states do not allow limitations on how long an implied warranty lasts so the above limitation may not apply to you.

LIMITATION OF REMEDIES AND EXCLUSION OF CONSEQUENTIAL AND INCIDENTAL DAMAGES: TIMBERTECH'S LIABILITIES ARE LIMITED SOLELY AND EXCLUSIVELY TO THE OBLIGATIONS SPECIFICALLY UNDERTAKEN HEREIN, AND UNDER NO CIRCUMSTANCES WILL TIMBERTECH BE LIABLE OR OBLIGATED FOR ANY INCIDENTAL, CONSEQUENTIAL, INDIRECT, SPECIAL, PUNITIVE OR ANY OTHER DAMAGES OF ANY KIND WHATSOEVER (INCLUDING, BUT NOT LIMITED TO, LOST PROFITS, LOST SALES, LOSS OF GOODWILL, USE OF MONEY, USE OF GOODS, STOPPAGE OF WORK, OR IMPAIRMENT OF ASSETS), WHETHER FORESEEABLE OR UNFORESEEABLE, ARISING OUT OF BREACH OR FAILURE OF EXPRESS OR IMPLIED WARRANTY, BREACH OF CONTRACT, FRAUD, MISREPRESENTATION, NEGLIGENCE, STRICT LIABILITY IN TORT OR OTHERWISE, EXCEPT AND ONLY TO THE EXTENT THIS LIMITATION IS SPECIFICALLY PRECLUDED BY APPLICABLE LAW OF MANDATORY APPLICATION. TIMBERTECH'S LIABILITY WITH RESPECT TO DEFECTIVE PRODUCTS SHALL IN NO EVENT EXCEED THE REPLACEMENT OF SUCH PRODUCTS OR REFUND OF THE PURCHASE PRICE, AS DESCRIBED ABOVE.

Some states do not allow the exclusion or limitation of incidental or consequential damages, so the above limitation or exclusion may not apply to you. This warranty gives you specific legal rights, and you may also have other rights that vary from state to state.

Miscellaneous: This writing is understood and intended to be the final expression of the parties' agreement and is a complete and exclusive statement of the terms and conditions with respect thereto, superseding all prior agreements or representations, oral or written, and all other communication between the parties relating to the subject matter of this agreement. This warranty may not be altered or amended except in a written instrument signed by TimberTech and Purchaser or permitted transferee. No agent, employee or any other party is authorized to make any warranty in addition to that made in this agreement and TimberTech shall not be bound by any such statements other than those contained in this warranty.

This warranty shall only be applicable and enforceable in the United States of America.

This warranty is effective for purchases (residential or commercial, as the case may be) made on or after January 1, 2011.

Copyright (c) 2012 TimberTech.

# Every TimberTech product is backed by exceptional customer service and a commitment to quality

## Warranty Registration is Easy

- The easiest way to register a warranty is to visit [www.timbertech.com](http://www.timbertech.com) and select the Warranty & Care link, then select Register Online.
- You may prefer to fill out the Warranty Card below and mail it to TimberTech, accordingly to the instructions on the card.

### Remember, to ensure your product is covered by the TimberTech Warranty it must be installed properly.

TimberTech LTD disclaims any liability or responsibility for the improper installation of this product. The purchaser is solely responsible for compliance with applicable local codes as to the deck's intended use. TimberTech recommends all designs be reviewed by a licensed architect, engineer or local building official before installation. TimberTech maintains a list of physical properties to assist the design professional.

Below is a chart showing which product each warranty covers. You can view warranty details online at [www.timbertech.com](http://www.timbertech.com):

- **Limited 25-Year Residential Warranty / Limited 10-Year Commercial Warranty**
  - Decking:** DockSider, Floorizon, ReliaBoard Plank, ValuPlank, Earthwood, TwinFinish, XLM
  - Railing:** Ornamental Rail, RadianceRail, BuilderRail (excluding all metal baluster components of BuilderRail System), Secure - Mount Post System, ADA Hand Rail System
  - Fencing:** All FenceScape products
  - Accessories:** CONCEALoc, DrySpace
- **Limited 10-Year Warranty for Metal Baluster Components of BuilderRail System**
- **Limited 5-Year Warranty for DeckLites System**

### To Make a Claim

To make a claim under either warranty, purchaser or the transferee, must send to TimberTech, within the warranty period referred to above, a description of the claimed defect and proof of purchase. Warranty Information Packets can be obtained from TimberTech.

#### TimberTech Limited

Attn: Claims Department • 894 Prairie Avenue, Wilmington, Ohio 45177 • Or call 1-800-307-7780

**TimberTech Customer:**  
Please complete this warranty card and mail to:

TimberTech  
894 Prairie Avenue  
Wilmington, Ohio 45177  
Attn: Warranty

**This information will help us better serve your needs.**  
Please return warranty card within 30 days of receipt of product.



Name: \_\_\_\_\_ Purchase Date: \_\_\_\_\_

Street Address: \_\_\_\_\_

City: \_\_\_\_\_ State/Province: \_\_\_\_\_ Zip/Postal Code: \_\_\_\_\_

Country: \_\_\_\_\_ Phone: \_\_\_\_\_

**Product Information:**

Where was your product purchased? \_\_\_\_\_

How was your product installed? \_\_\_\_\_

Contractor Name: \_\_\_\_\_  Self-Installed

**Warranty Registration: Check the TimberTech product that you purchased:**

**Decking:**  Earthwood Evolutions™ Plank  ReliaBoard™ Plank  Accessories:  
 Floorizon® Plank  XLM® Plank \_\_\_\_\_  
 DockSider™ Plank  TwinFinish® Plank

**Railing:**  RadianceRail®  Ornamental Rail  BuilderRail®  Metal Balusters  CableRail  
 RadianceRail® Express  Evolutions Rail™  Secure-Mount System  ADA Hand Rail System

DrySpace™  DeckLites®  FenceScape®

**Demographic Information:** Number of residents in household: \_\_\_\_\_

Number of household residents in the following age groups:

0-12  13-18  19-27  28-39  40-55  55+

Average household income:

Under \$35,000  \$35,000-50,000  \$50,000-70,000  \$70,000-95,000  \$95,000+

High-Performance Decking. Low-Maintenance Living. It's Our Passion.

