



274 Middle Island Rd.
Medford, NY 11763

1-631-698-0900
1-800-339-3362
Fax# 1-631-698-6408
www.easternfence.com

ALUMINUM POST CAPS



Item No.	Size	Case Quantity	Each	Case Qty. Each
APC138	1-3/8"	500		
APC158	1-5/8"	400		
APC200	2"	275		
APC250	2-1/2"	150		
APC300	3"	100		

GALVANIZED POST CAPS



Item No.	Size	Case Quantity	Each	Case Qty. Each
GPC158	1-5/8"	100		
GPC200	2"	75		
GPC250	2-1/2"	50		
GPC300	3"	50		
GPC350	3-1/2"	25		
GPC400	4"	25		
GPC658	6-5/8"	10		
GPC858	8-5/8"	8		

ALUMINUM PLUGS



Item No.	Size	Case Quantity	Each	Case Qty. Each
ADC138	1-3/8"	600		
AP158	1-5/8"	250		
AP200	2"	250		

**COMBINE 10 CASES OF ANY ITEMS FROM PAGES C1 - C19 FOR 20% DISCOUNT
(EXCLUDING ITEMS WITH "◆" SYMBOL)**

04/01/12



"WHEN IT COMES TO QUALITY, SERVICE AND PRICE, NO ONE DOES IT BETTER"



274 Middle Island Rd.
Medford, NY 11763

1-631-698-0900
1-800-339-3362
Fax# 1-631-698-6408
www.easternfence.com

ALUMINUM LINE TOPS



Item No.	Size	Case Quantity	Each	Per 100 Each	Case Qty. Each
ALT153	1-5/8" X 1-3/8"	175			
ALT213	2" X 1-3/8"	150			
ALT215	2" X 1-5/8"	150			
ALT255	2-1/2" X 1-5/8"	100			

GALVANIZED LINE TOPS



Item No.	Size	Case Quantity	Each	Case Qty. Each
GLT215	2" X 1-5/8"	50		
GLT255	2-1/2" X 1-5/8"	30		
GLT315	3" X 1/5/8"	20		
GLT355	3-1/2" X 1-5/8"	20		
GLT415	4" X 1-5/8"	30		

GALVANIZED SLEEVES



Item No.	Size	Case Quantity	Each	Case Qty. Each
GSL138	1-3/8"	100		
GSL158	1-5/8"	100		



COMBINE 10 CASES OF ANY ITEMS FROM PAGES C1 - C19 FOR 20% DISCOUNT
(EXCLUDING ITEMS WITH "◆" SYMBOL)

04/01/12

"WHEN IT COMES TO QUALITY, SERVICE AND PRICE, NO ONE DOES IT BETTER"



274 Middle Island Rd.
Medford, NY 11763

1-631-698-0900
1-800-339-3362
Fax# 1-631-698-6408
www.easternfence.com

TENSION BANDS - STANDARD

Item No.	Size	Case Quantity	Each	Case Qty. Each
PTB138	1-3/8"	250		
PTB158	1-5/8"	250		
PTB200	2"	250		
PTB250	2-1/2"	250		
PTB300	3"	100		



TENSION BANDS - BEVELED

Item No.	Size	Case Quantity	Each	Case Qty. Each
BTB138	1-3/8"	250		
BTB158	1-5/8"	250		
BTB200	2"	250		
BTB250	2-1/2"	250		
BTB300	3"	100		
BTB350	3-1/2"	100		
BTB400	4"	100		
BTB658	6-5/8"	50		
BTB858	8-5/8"	50		



BRACE BANDS - STANDARD

Item No.	Size	Case Quantity	Each	Case Qty. Each
PBB158	1-5/8"	250		
PBB200	2"	250		
PBB250	2-1/2"	250		
PBB300	3"	100		



BRACE BANDS - BEVELED

Item No.	Size	Case Quantity	Each	Case Qty. Each
BBB138	1-3/8"	300		
BBB158	1-5/8"	300		
BBB200	2"	250		
BBB250	2-1/2"	250		
BBB300	3"	200		
BBB350	3-1/2"	100		
BBB400	4"	100		
BBB658	6-5/8"	50		
BBB858	8-5/8"	50		



COMBINE 10 CASES OF ANY ITEMS FROM PAGES C1 - C19 FOR 20% DISCOUNT
(EXCLUDING ITEMS WITH "◆" SYMBOL)

04/01/12



"WHEN IT COMES TO QUALITY, SERVICE AND PRICE, NO ONE DOES IT BETTER"



274 Middle Island Rd.
Medford, NY 11763

1-631-698-0900
1-800-339-3362
Fax# 1-631-698-6408
www.easternfence.com

BOULEVARD CLAMPS – w/o bolt

Item No.	Size	Bolt Required	Case Qty.	Each	Case Qty. Each
BVD138	1-3/8" x 1-3/8"	5/16" x 2"	150		
BVD153	1-5/8" x 1-3/8"	5/16" x 2"	100		
BVD158	1-5/8" x 1-5/8"	5/16" x 2"	100		
BVD200	2" x 2"	5/16" 2-1/2"	100		
BVD213	2" x 1-3/8"	5/16" x 3"	125		
BVD215	2" x 1-5/8"	5/16" x 3"	50		
BVD255	2-1/2" x 1-5/8"	3/8" x 2-1/2"	50		
BVD315	3" x 1-5/8"	3/8" x 2-1/2"	50		
BVD355	3-1/2" x 1-5/8"	3/8" x 2-1/2"	50		
BVD415	4" x 1-5/8"	3/8" x 2-1/2"	50		



END CLAMPS – w/o bolt

Item No.	Size	Bolt Required	Case Qty.	Each	Case Qty. Each
EC138	1-3/8" x 1-3/8"	5/16" x 2"	100		
EC158	1-5/8" x 1-5/8"	3/8" x 2-1/2"	100		
EC213	2" x 1-3/8"	5/16" x 2"	100		
EC215	2" x 1-5/8"	3/8" x 2-1/2"	100		
EC200	2" x 2"	5/16" x 3"	100		
EC255	2-1/2" x 1-5/8"	3/8" x 2-1/2"	100		
EC315	3" x 1-5/8"	3/8" x 2-1/2"	100		
EC355	3-1/2" x 1-5/8"	3/8" x 2-1/2"	50		
EC415	4" x 1-5/8"	3/8" x 2-1/2"	100		



CORNER RAIL CLAMP – w/o bolt

Item No.	Size	Bolt Required	Case Qty.	Each	Case Qty. Each
CRC255	2-1/2" x 1-5/8"	5/16" x 2-1/2"	100		
CRC315	3" x 1-5/8"	5/16" x 2-1/2"	100		



SADDLE CLAMP – w/o bolt

Item No.	Size	Bolt Required	Case Qty.	Each	Case Qty. Each
SC138	1-3/8" x 1-3/8"	5/16" x 1-1/4"	125		
SC158	1-5/8" x 1-5/8"	3/8" x 2-1/2"	100		
SC200	2" x 2"	3/8" x 3"	100		

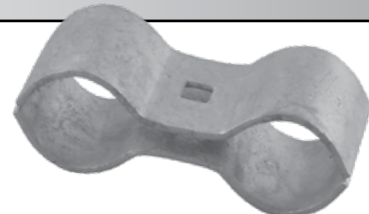

COMBINE 10 CASES OF ANY ITEMS FROM PAGES C1 - C19 FOR 20% DISCOUNT
(EXCLUDING ITEMS WITH "◆" SYMBOL)

04/01/12

"WHEN IT COMES TO QUALITY, SERVICE AND PRICE, NO ONE DOES IT BETTER"



274 Middle Island Rd.
Medford, NY 11763

1-631-698-0900
1-800-339-3362
Fax# 1-631-698-6408
www.easternfence.com

ALUMINUM RAIL ENDS

Item No.	Size	Case Qty.	Each	Per 100 Each	Case Qty. Each
ARE138	1-3/8"	400			
ARE158	1-5/8"	300			



GALVANIZED RAIL ENDS

Item No.	Size	Case Qty.	Each	Per 100 Each	Case Qty. Each
GRE138	1-3/8"	100			
BRE158	1-5/8"	100			
GRE200	2"	50			

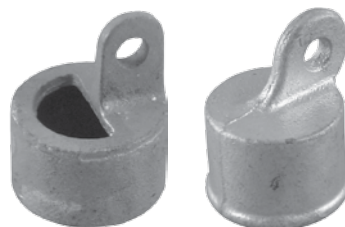

CARRIAGE BOLTS

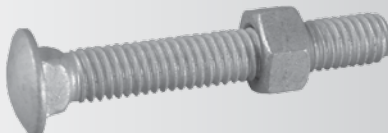

Item No.	Size	Boxes/Case Case Qty.	Per 100 Box	Case Qty. Per 100 Box
NB5125	5/16" x 1-1/4"	20		
NB5150	5/16" x 1-1/2"	10		
NB5250	5/16" x 2-1/2"	10		
NB3150	3/8" x 1-1/2"	10		
NB3200	3/8" x 2"	10		
NB3250	3/8" x 2-1/2"	10		
NB3300	3/8" x 3"	10		
NB3350	3/8" x 3-1/2"	10		



COMBINE 10 CASES OF ANY ITEMS FROM PAGES C1 - C19 FOR 20% DISCOUNT
(EXCLUDING ITEMS WITH "◆" SYMBOL)

04/01/12

C5

"WHEN IT COMES TO QUALITY, SERVICE AND PRICE, NO ONE DOES IT BETTER"



274 Middle Island Rd.
Medford, NY 11763

1-631-698-0900
1-800-339-3362
Fax# 1-631-698-6408
www.easternfence.com

ALUMINUM FENCE TIES – 100 Ties Per Bag

Item No.	Wire Gauge	Description (Pipe Size)	Shank Length	# Bags Per Case	Per Bag	Per Bag By Case
AFT9S	9	#13 1-5/8"	6-1/2"	37		
AFT9L	9	#16 2-1/2"	8-1/4"	31		
AFT6S	6	#23 1-5/8"	6-1/2"	23		
AFT6L	6	#26 2-1/2"	8-1/4"	18		

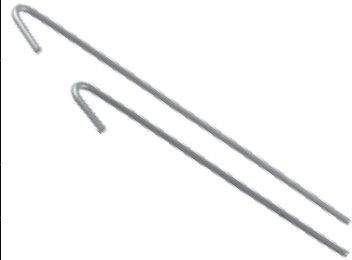

STEEL FENCE TIES, GALV. – 100 Ties Per Bag

Item No.	Wire Gauge	Description (Pipe Size)	Shank Length	# Bags Per Case	Per Bag	Per Bag By Case
SFT9L	9	Hook - to 2-1/2"	8-1/4"	10		
SFT9S	9	Hook - to 1-5/8"	6-1/2"	10		
SFT13	13	Straight for Double Wrap	15-1/2"	20		
SFT14	14	Double Loop	12"	25		
RRTIESS	18	SS Double Loop	8"	50		

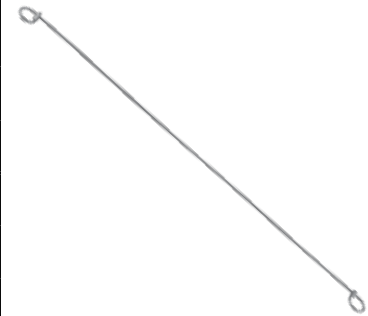

FABRIC ANCHORS – Galvanized Steel

Item No.	Type	Std Pkg. Quantity	Per 100 Each	Std. Pkg.
FAH	Fabric Hook	250		



COMBINE 10 CASES OF ANY ITEMS FROM PAGES C1 - C19 FOR 20% DISCOUNT
(EXCLUDING ITEMS WITH "◆" SYMBOL)

04/01/12

“WHEN IT COMES TO QUALITY, SERVICE AND PRICE, NO ONE DOES IT BETTER”



274 Middle Island Rd.
Medford, NY 11763

1-631-698-0900
1-800-339-3362
Fax# 1-631-698-6408
www.easternfence.com

POST HINGES - MALLEABLE

Item No.	Size	Case Qty.	Each	Per 100 Ea. by Case
MPH200	2" Mall. U-Bolt	50		
MPH250	2-1/2" Mall. U-Bolt	50		
MPH300	3" Mall. U-Bolt	50		

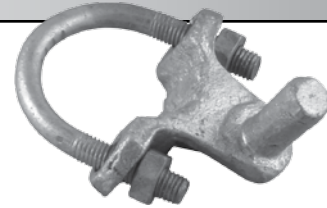

POST HINGES - PRESSED STEEL

Item No.	Size	Bolt Required	Case Qty.	Each w/N&B	Per 100 Ea. by Case w/o N&B
PPH200	2" Pressed Steel 1-1/4"	3/8" x 2-1/2"	50		
PPH250	2-1/2" Pressed Steel 1-1/4"	3/8" x 3"	50		
PPH300	3" Pressed Steel 1-1/4"	3/8" x 3-1/2"	50		
WMH	5/8" Pin Wall Mount	N/A	100		



FRAME HINGE - MALLEABLE

Item No.	Size	Case Qty.	Each	Per 100 Ea. by Case
MFH138	1-3/8" Malleable	50		
MFH158	1-5/8" Malleable	80		



FRAME HINGE - PRESSED STEEL

Item No.	Size	Bolt Required	Case Qty.	Each w/N&B	Per 100 Ea. by Case w/o N&B
PFH138	1-3/8" Pressed Steel 1"	3/8" x 2"	100		
PFH158	1-5/8" Pressed Steel 1-1/4"	3/8" x 2-1/2"	50		



COMBINE 10 CASES OF ANY ITEMS FROM PAGES C1 - C19 FOR 20% DISCOUNT
(EXCLUDING ITEMS WITH "◆" SYMBOL)

04/01/12



"WHEN IT COMES TO QUALITY, SERVICE AND PRICE, NO ONE DOES IT BETTER"



274 Middle Island Rd.
Medford, NY 11763

1-631-698-0900
1-800-339-3362
Fax# 1-631-698-6408
www.easternfence.com

OARLOCKS - COMPLETE

Item No.	Size	Each	Per 100 Each
OAR138	1-3/8" X 1-3/8"		
OAR213	2" X 1-3/8"		
OAR253	2-1/2" X 1-3/8"		
OAR313	3" X 1-3/8"		
OAR215	2" X 1-5/8"		
OAR255	2-1/2" X 1-5/8"		
OAR315	3" X 1-5/8"		
OAR402	4" X 2"		



FORK ONLY

Item No.	Size	Case Quantity	Per 100 Each
FORK138	1-3/8"	150	
FORK200	2"	120	
FORK250	2-1/2"	80	
FORK300	3"	100	
FORK400	4"	100	



COLLARS ONLY

Item No.	Size	Case Quantity	Per 100 Each
COL138	1-3/8"	150	
COL158	1-5/8"	120	
COL200	2"	100	



DROP FORK BRACKETS

Item No.	Size	Case Quantity	Per 100 Each
DFB			



COMBINE 10 CASES OF ANY ITEMS FROM PAGES C1 - C19 FOR 20% DISCOUNT
(EXCLUDING ITEMS WITH "◆" SYMBOL)

04/01/12

"WHEN IT COMES TO QUALITY, SERVICE AND PRICE, NO ONE DOES IT BETTER"



274 Middle Island Rd.
Medford, NY 11763

1-631-698-0900
1-800-339-3362
Fax# 1-631-698-6408
www.easternfence.com

AUTO LATCH - CHILD PROOF LATCH

(Other Sizes Available)

Item No.	Size	Each	Per 25 Each	
AUTO138 ♦	1-3/8" x 1-3/8"			
AUTO213 ♦	2" x 1-3/8"			
AUTO215 ♦	2" x 1-5/8"			
AUTO253 ♦	2-1/2" x 1-3/8"			
AUTO255 ♦	2-1/2" x 1-5/8"			
AUTO315 ♦	3" x 1-5/8"			

MAGNA LATCH

MAGNETIC LATCHING-KEY LOCKING

Item No.	Size	Each	Per 25 Each	
MLDD- ♦	TOP PULL 20"			
MLS- ♦	VERTICAL PULL 7"			
MLA- ♦	C/L ADAPTER KIT			

KENNEL LATCH

Item No.	Size	Each	Per 10 Each	
KL	1-3/8" x 1-3/8"			

CLAW CLOSER

Item No.	Size	Each	Per 50 Each	
CC213	2" x 1-3/8"			
CC253	2-1/2" x 1-3/8"			

COMBINE 10 CASES OF ANY ITEMS FROM PAGES C1 - C19 FOR 20% DISCOUNT
(EXCLUDING ITEMS WITH "♦" SYMBOL)

04/01/12



"WHEN IT COMES TO QUALITY, SERVICE AND PRICE, NO ONE DOES IT BETTER"



274 Middle Island Rd.
Medford, NY 11763

1-631-698-0900
1-800-339-3362
Fax# 1-631-698-6408
www.easternfence.com

KANT-SLAM HYDRAULIC GATE CLOSER

Item No.	Each	Per 24 Each
----------	------	-------------

HDGC

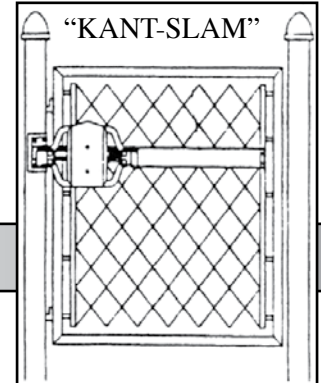
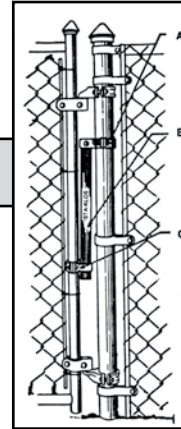

← "STA-KLOS"

"STA-KLOS" GATE CLOSER

Item No.	Size	Each	Per 25 Each
----------	------	------	-------------

STA200

2"

STA250

2-1/2"

RESIDENTIAL LOCKING DEVICE

For 1-3/8" frame, double gates. Acts as both latch and drop rod. Positive locking.

Item No.	Size	Each	Per 10 Each
----------	------	------	-------------

RLD

1-3/8" x 1-3/8" x 36"

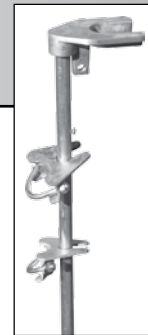

DROP RODS

Item No.	Size	Each	Per 25 Each
----------	------	------	-------------

RDR ♦

Drop Rod

PFH138

Guides 1-3/8"



SCROLLS

Item No.	Size	Each	Per 50 Each
----------	------	------	-------------

SCR18 ♦

18"



COMBINE 10 CASES OF ANY ITEMS FROM PAGES C1 - C19 FOR 20% DISCOUNT
(EXCLUDING ITEMS WITH "♦" SYMBOL)

04/01/12

"WHEN IT COMES TO QUALITY, SERVICE AND PRICE, NO ONE DOES IT BETTER"



274 Middle Island Rd.
Medford, NY 11763

1-631-698-0900
1-800-339-3362
Fax# 1-631-698-6408
www.easternfence.com

GATE CLIPS

Item No.	Size	Case Quantity	Each	Case Qty. Each	
GC138	1-3/8"	300			

ALUMINUM GATE CORNERS

Item No.	Size	Each	Per 100 Each	
AGC138	1-3/8" w/n & b			

STEEL GATE CORNERS

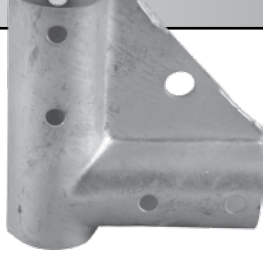
Item No.	Size	Each	Per 50 Each	
SGC	1-5/8"			

GATE CENTER STOP

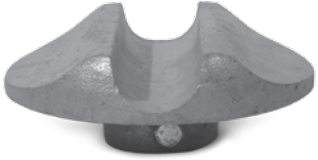
Item No.	Each	Per 10 Each	
GCS			

GATE HOLD BACK

Item No.	Each	Per 25 Each	
GHB			

COMBINE 10 CASES OF ANY ITEMS FROM PAGES C1 - C19 FOR 20% DISCOUNT
(EXCLUDING ITEMS WITH "◆" SYMBOL)

04/01/12



"WHEN IT COMES TO QUALITY, SERVICE AND PRICE, NO ONE DOES IT BETTER"



274 Middle Island Rd.
Medford, NY 11763

1-631-698-0900
1-800-339-3362
Fax# 1-631-698-6408
www.easternfence.com

INDUSTRIAL HINGES - MALLEABLE - 180

(1-5/8" OR 2" FRAME)

Item No.	Size	Each	Per 12 Each
IOH250	2-1/2"		
IOH300	3"		
IOH400	4"		
IOH658	6-5/8"		



INDUSTRIAL BOX HINGES MALLEABLE

(1-5/8" OR 2" FRAME)

Item No.	Size	Each	Per 12 Each
IBH250	2-1/2"		
IBH300	3"		
IBH350	3-1/2"		
IBH400	4"		
IBH658	6-5/8"		
IBH858	8-5/8"		
180ATT	180 Attach.		

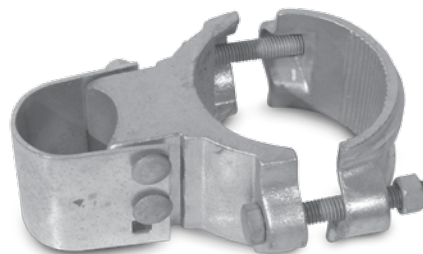

SWING GATE WHEELS

Item No.	Size	Each	Per 10 Each
FEGR	Cantilever Front End Ground Roller		
SGRCL	For Pipe Frames		
SGRW	For Wood Frames		
SGRSL	Spring Loaded Helper Wheel		

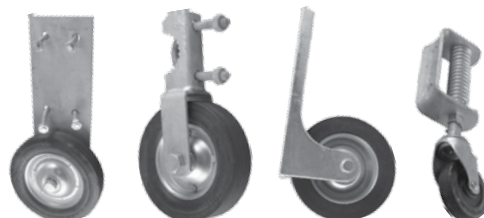

INDUSTRIAL LOCKING DEVICE

Item No.	Size	Each	Per 24 Each
ILD	1-5/8" or 2"		



INDUSTRIAL LOCKING DEVICE PRESSED STEEL - 3 GUIDES

Item No.	Size	Each	Per 20 Each
PILD	1-5/8" or 2"		

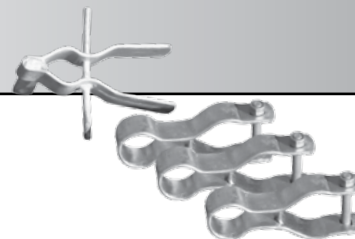

COMBINE 10 CASES OF ANY ITEMS FROM PAGES C1 - C19 FOR 20% DISCOUNT
(EXCLUDING ITEMS WITH "◆" SYMBOL)

04/01/12

"WHEN IT COMES TO QUALITY, SERVICE AND PRICE, NO ONE DOES IT BETTER"



274 Middle Island Rd.
Medford, NY 11763

1-631-698-0900
1-800-339-3362
Fax# 1-631-698-6408
www.easternfence.com

FULCRUM LATCHES

Item No.	Type	Size	Per 10 Each
FUL250	SINGLE GATE	2-1/2"	
FUL300	SINGLE GATE	3"	
FUL400	SINGLE GATE	4"	
FUL200	DOUBLE GATE	1-5/8" or 2"	
HSGL	HI SECURITY LATCH-DBL GATE	1-5/8" or 2"	



CANTILEVER LATCH - SINGLE LEAF

Item No.	Size	Case Quantity	Each	Per Case Each
CL300	3"	10		
CL400	4"	8		



CANTILEVER LATCH - DOUBLE LEAF

Item No.	Size	Each	Per 10 Each
RGL-000	2" X 2" (Requires 2 Beveled Brace Bands)		



CANTILEVER ROLLER

Item No.	Size	Each	Per 10 Each
CR300	3" X 2-1/2" or 2"		
CR400	4" x 2-1/2" or 2"		
CR400N	4" x 2-1/2" or 2" NYLON		
CR658	6-5/8" or 2-1/2" or 2"		

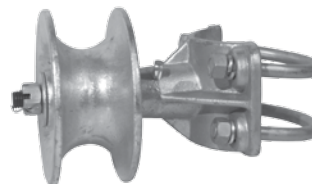

CANTILEVER ROLLER GUARD

MUST ORDER GUARD WITH EACH ROLLER

Item No.	Size	Each	Per 10 Each
CRGUARD			



COMBINE 10 CASES OF ANY ITEMS FROM PAGES C1 - C19 FOR 20% DISCOUNT
(EXCLUDING ITEMS WITH "◆" SYMBOL)



04/01/12

"WHEN IT COMES TO QUALITY, SERVICE AND PRICE, NO ONE DOES IT BETTER"



274 Middle Island Rd.
Medford, NY 11763

1-631-698-0900
1-800-339-3362
Fax# 1-631-698-6408
www.easternfence.com

ROLLING GATE KITS

H-128 - ITEM #H128KIT COST \$ _____ EACH

Includes:

- 1 #DWC-128 12" wide carrier with 8" wheels
- 1 #RGL-000 Latch (Req. 2 brace bands - not incl.)
- 6 #UTB-278 Universal Track Bracket (2", 2-1/2" or 3" O.D.)
- 2 #SPW-000 Track wheels
- 2 #PWB-158 Wheel brackets for 1-5/8" frame
- 2 #PWB-178 Wheel brackets for 2" frame

"BEVELED EDGE BANDS" are recommended wherever attaching bands are required.

FRAME CONFIGURATION

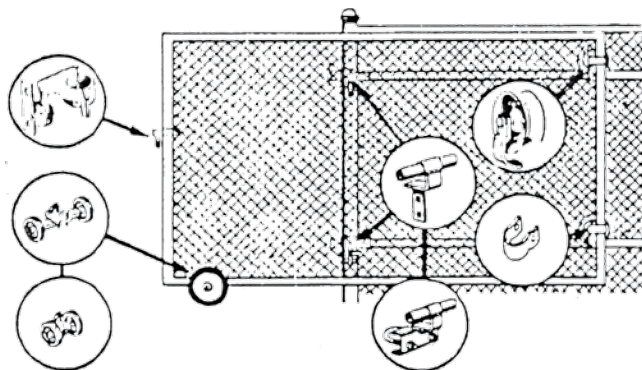
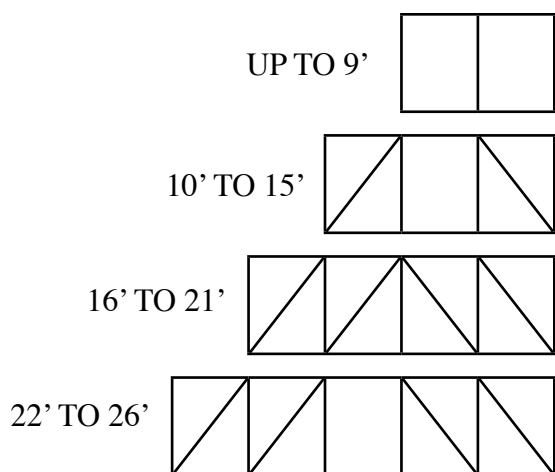

C14

COMBINE 10 CASES OF ANY ITEMS FROM PAGES C1 - C19 FOR 20% DISCOUNT
(EXCLUDING ITEMS WITH "◆" SYMBOL)

04/01/12









"WHEN IT COMES TO QUALITY, SERVICE AND PRICE, NO ONE DOES IT BETTER"



274 Middle Island Rd.
Medford, NY 11763

1-631-698-0900
1-800-339-3362
Fax# 1-631-698-6408
www.easternfence.com

ROLLING GATE HARDWARE

Item No.	Description	Each	Photo
DWC-128	12" wide carrier with 8" wheels		
DWCRR-128	12" wide carrier Rut Runner 8" Pneu.		
RGL-000	Latch, lockable (Requires 2 Bev. Brace Bands)		
UTB-278	Universal track bracket (2-1/2", or 3")		
RTB-000	Track Bracket		
SPW-000	Track Wheels		
PWB-158	Wheel bracket for 1-5/8" frame		
PWB-178	Wheel bracket for 2" frame		

COMBINE 10 CASES OF ANY ITEMS FROM PAGES C1 - C19 FOR 20% DISCOUNT
(EXCLUDING ITEMS WITH "◆" SYMBOL)

04/01/12



"WHEN IT COMES TO QUALITY, SERVICE AND PRICE, NO ONE DOES IT BETTER"



274 Middle Island Rd.
Medford, NY 11763

1-631-698-0900
1-800-339-3362
Fax# 1-631-698-6408
www.easternfence.com

BARB WIRE

Item No.	Size	Per Roll	Pallets
BW15	BARB WIRE 15-1/2GA 4-PT CLASS 3 GALV 1320' SPOOL		
BW3	BARB WIRE 12-1/2GA 4-PT CLASS 3 GALV 1320' SPOOL		
BWAZ	Barb Wire 12-1/2" Ga. Aluminized 1000' Spool		



1-PIECE STEEL BARB ARM

Item No.	Size	Each	Per 25 Each
BA158	1-5/8" x 1-5/8"		
BA215	2" x 1-5/8"		
BA255	2-1/2" x 1-5/8"		
BA315	3" x 1-5/8"		



1-PIECE STEEL BARB V-ARM

Item No.	Size	Each	Per 30 Each
VA250	2-1/2" x 1-5/8"		



MAL. CORNER BARB ARM

Item No.	Size	Each	Per 30 Each
CBA250	2-1/2"		
CBA300	3"		
CBA400	4"		



MAL. CORNER V-ARMS

Item No.	Size	Each	Per 30 Each
CBA6250	2-1/2"		
CBA6300	3"		
CBA6400	4"		



C16

COMBINE 10 CASES OF ANY ITEMS FROM PAGES C1 - C19 FOR 20% DISCOUNT
(EXCLUDING ITEMS WITH "◆" SYMBOL)

04/01/12

"WHEN IT COMES TO QUALITY, SERVICE AND PRICE, NO ONE DOES IT BETTER"



274 Middle Island Rd.
Medford, NY 11763

1-631-698-0900
1-800-339-3362
Fax# 1-631-698-6408
www.easternfence.com

STEEL BARB ARM BLADE 3 - Wire Z-Slot

Item No.	Each	Per 40 Each	
BABL			

STEEL BARB WIRE ARM BASE

Item No.	Size	Each	Per 50 Each	
GBAB158	1-5/8" x 1-5/8"			
GBAB215	2" x 1-5/8"			
GBAB255	2-1/2" x 1-5/8"			
GBAB315	3" x 1-5/8"			
GBAB355	3-1/2" x 1-5/8"			
GBAB415	4" x 1-5/8"			

▲ 10 CASE MIX ABOVE FOR 20% DISCOUNT ▲

CANTILEVER BARB ARM

Item No.	Each	Per 24 Each	
BAC ♦			

QUICK SET ANCHORING CEMENT

Item No.	Description	Each	Per 36 Each	
EQS ♦	50-lb. Pail			

**COMBINE 10 CASES OF ANY ITEMS FROM PAGES C1 - C19 FOR 20% DISCOUNT
(EXCLUDING ITEMS WITH "♦" SYMBOL)**

04/01/12

C17

"WHEN IT COMES TO QUALITY, SERVICE AND PRICE, NO ONE DOES IT BETTER"



274 Middle Island Rd.
Medford, NY 11763

1-631-698-0900
1-800-339-3362
Fax# 1-631-698-6408
www.easternfence.com

GALVANIZED TENSION BARS

Item No.	Size	Size	Each	Per Bdle (25)	Per 4 Bdls (100)	Master Bdls
TB3 ♦	36"	5/8" x 3/16"				
TB42 ♦	42"	5/8" x 3/16"				
TB4 ♦	48"	5/8" x 3/16"				
TB5 ♦	60"	5/8" x 3/16"				
TB6 ♦	72"	5/8" x 3/16"				
TBH6 ♦	72"	3/4" x 3/16"				
TBH7 ♦	84"	3/4" x 3/16"				
TBH8 ♦	96"	3/4" x 3/16"				
TBH10 ♦	120"	3/4" x 3/16"				
TBH12 ♦	144"	3/4" x 3/16"				
TBL12 ♦	144" Steel	3/16" x 3/8"				
KR12 ♦	144"	5/16" Rod				

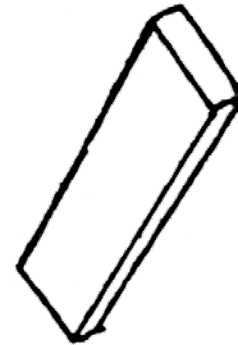

TRUSS RODS

Item No.	Each	Per 100 Each
TRA ♦	Type "A" - 3/8" x 11' Truss Rod w/nut	
TRT ♦	Truss Rod Tightener	

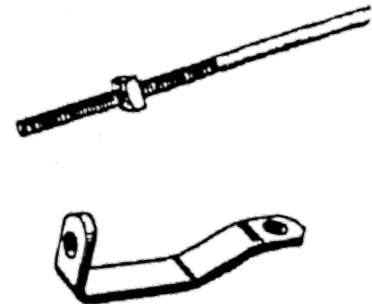

HOG RINGS

Item No.	Package	Per 5LB Bag
AHR ♦	ALUMINUM	
GHR ♦	GALVANIZED	



C18

COMBINE 10 CASES OF ANY ITEMS FROM PAGES C1 - C19 FOR 20% DISCOUNT
(EXCLUDING ITEMS WITH "♦" SYMBOL)

04/01/12

"WHEN IT COMES TO QUALITY, SERVICE AND PRICE, NO ONE DOES IT BETTER"



274 Middle Island Rd.
Medford, NY 11763

1-631-698-0900
1-800-339-3362
Fax# 1-631-698-6408
www.easternfence.com

COIL SPRING WIRE Available in Black (BK), Brown (BR), Eastern Green (eg)

Item No.	Description	Per Roll	
CW6 ♦	6 ga. PVC x 1000'		
CW9 ♦	9 ga. PVC x 1000'		
GSW7 ♦	7 ga. galv. x 1000'		
AZSW7 ♦	7 ga. alumz. x 1000'		

GALVANIZED CHAIN

Item No.	Size	Std Pkg.	Each	Per Ft St. Pkg.	
CHAIN ♦					

BACKSTOP "EL"

Item No.	Each	Per 10 Each	
BSL			

MALLEABLE FLOOR FLANGE

Item No.	Size	Std Pkg.	Each	Per Pkg. Each	
MFF200	2"	10			
MFF250	2-1/2"	12			
MFF300	3"	12			

FLOOR FLANGE - STEEL WELDABLE (Other Sizes in Stock)

Item No.	Size	Each	Per 100 Each	
FF4414	FLOOR FLANGE PLATE 4" X 4" X 1/4"			
FF6614	FLOOR FLANGE PLATE 6" X 6" X 1/4"			
FF6638	FLOOR FLANGE PLATE 6" X 6" X 3/8"			
FF8814	FLOOR FLANGE PLATE 8" X 8" X 1/4"			
FF8838	FLOOR FLANGE PLATE 8" X 8" X 3/8"			

COMBINE 10 CASES OF ANY ITEMS FROM PAGES C1 - C19 FOR 20% DISCOUNT
(EXCLUDING ITEMS WITH "♦" SYMBOL)

04/01/12



"WHEN IT COMES TO QUALITY, SERVICE AND PRICE, NO ONE DOES IT BETTER"



274 Middle Island Rd.
Medford, NY 11763

1-631-698-0900
1-800-339-3362
Fax# 1-631-698-6408
www.easternfence.com

OVERHEAD SLIDE GATE SYSTEMS

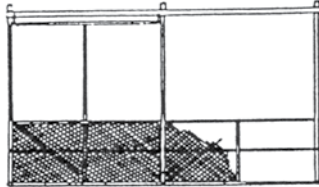

A Complete Hardware Set Includes the Following:

Single

- 2 - Trolley Assemblies, 3-Guide Assemblies
- 1 - Stop Assembly, 1-Locking Stop Assembly
- 1 - Locking Bracket, 3 - Hanger Assemblies
- 1 - Beam Plate

Double

- 6 - Trolley Assemblies, 4 - Guide Assemblies, 1 - Latch Assembly
- 4 - Hanger Assemblies, 2 - Beam Plates, 1- Track Center Stop
- 2 - Stop Assemblies

BEAM HANGER ASSEMBLY			
Item No.	Description	Wt. Each	Price
2031S	Beam Hanger for 4" O.D. Post	12.250#	
2035S	Beam Splice Plate	1.000#	
2036S	Beam Hanger for Double 4" Post	15.000#	
2000S	Trolley & Wheel Assembly	8.000#	
2003S	4 Wheel Trolley	8.000#	
GUIDE ASSEMBLY			
Item No.	Description	Wt. Each	Price
2006S	4"	7.000#	
STOP ASSEMBLY			
Item No.	Description	Wt. Each	Price
2011S	4"	3.000#	
LOCKING STOP ASSEMBLY			
Item No.	Description	Wt. Each	Price
2016S	4"	2.250#	
2018S	Locking Bracket	.500#	
I-BEAM OVERHEAD TRACK			
Item No.	Description	Wt. Each	Price
2050S	5" I-Beam x 20'	12.500#	



2036S



2000S



2003S



2035S

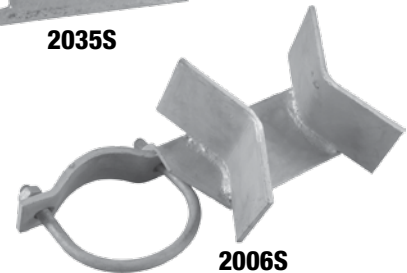

2006S



2016S



2018S



2050S



04/01/12

“WHEN IT COMES TO QUALITY, SERVICE AND PRICE, NO ONE DOES IT BETTER”



274 Middle Island Rd.
Medford, NY 11763

1-631-698-0900
1-800-339-3362
Fax# 1-631-698-6408
www.easternfence.com

**SLIDING GATE TRACK SYSTEMS
LIGHT WEIGHT GATES GALVANIZED**

Item No.	Description	Each	Price Per Ft.	Photo
5116	(400 LBS. MAX.)	6'-24' (Sold in 2' increments)		
1050T	TRUCK w/4-1/2" Bolt			
51F	SINGLE BRACKET			
51G	SINGLE SPLICE			
51HS	DOUBLE SPACED BRACKET			
51ED	END CAP			
325	ADJUSTABLE GUIDE			

Heavier Rail and Specialty Items Available Upon Request
"GATE PRICES – CALL FOR QUOTE"

04/01/12



"WHEN IT COMES TO QUALITY, SERVICE AND PRICE, NO ONE DOES IT BETTER"



274 Middle Island Rd.
Medford, NY 11763

1-631-698-0900
1-800-339-3362
Fax# 1-631-698-6408
www.easternfence.com

SPEED RAIL FITTINGS ALUMINUM

Item No. Each	1-3/8" O.D. Item No. Ea.	1-5/8" O.D. Item No. Ea.	2" O.D. Item No. Ea.	2-1/2" O.D. Item No. Ea.
3 ELBOW	SR1383	SR1583	SR2003	SR2503
5 TEE	SR1385	SR1585	SR2005	SR2505
7 CROSS	SR1387	SR1587	SR2007	SR2507
9 SIDE OUT. ELL.	SR1389	SR1589	SR2009	SR2509
11 SIDE OUT. TEE	SR13811	SR15811	SR20011	SR25011
13 SIDE OUT. CROSS	SR13813	SR15813	SR20013	
17 ADJ. TEE	SR13817	SR15817	SR20017	
19 ADJ. CROSS	SR13819	SR15819	SR20019	
23 ADJ. TEE/CROSS	SR13823	SR15823	SR20023	
41 ADJ. WALL FLANGE	SR13841	SR15841	SR20041	
47 RECT. BASE FLANGE	SR13847	SR15847	SR20047	SR25047
60 PLUG (for use w/ Sched. 40 Pipe)				SR25060
62 PLUG (for use w/ Sched. 40 Pipe)	SR13862	SR15862	SR20062	

MALLEABLE IRON GALVANIZED FITTINGS ALSO AVAILABLE

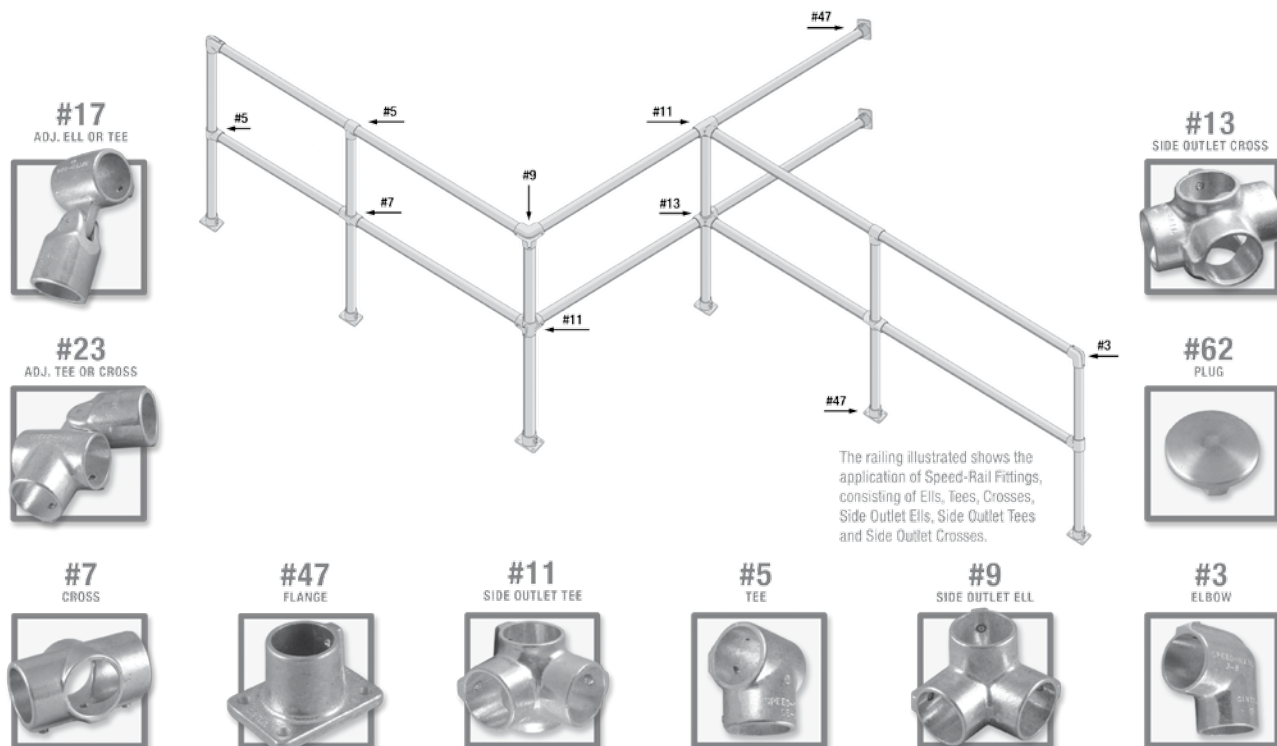

04/01/12

“WHEN IT COMES TO QUALITY, SERVICE AND PRICE, NO ONE DOES IT BETTER”



274 Middle Island Rd.
Medford, NY 11763

1-631-698-0900
1-800-339-3362
Fax# 1-631-698-6408
www.easternfence.com



RAZOR RIBBON BARBED OBSTACLE TAPES

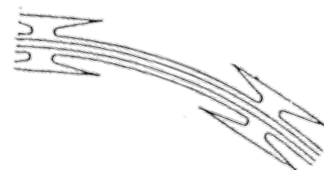

Item No.	Size	Ft./Roll	Attachment Spacing	1-9 Rolls	10-25 Rolls	26-50 Rolls
RR18 GALV	18" dia	50'	18"			
RR18	18" dia	50'	18"			

PLEASE CALL FOR QUOTE FOR OVER 50 ROLLS

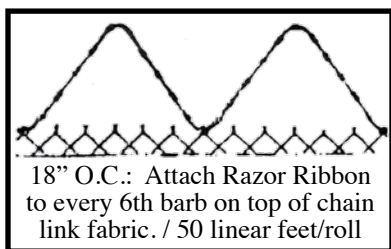

Recommended for general commercial security purposes.

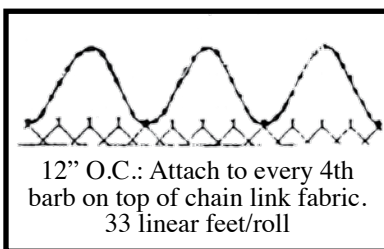

Recommended for commercial facilities which require high security.

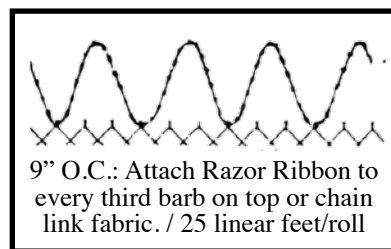

Recommended for correctional and other highly sensitive areas.

- TOOLS:** Automatic Tie Twisting Tool #FTT EACH
- TIES:** Steel 16 Gauge Double Loop 6-1/2" #SFT16
Stainless Steel 18GA Double Loop 8" #RRTIESS

*Barbed tape products are not designed or intended for residential application. These products are not to be used as ground barriers on commercial applications. Ground barriers should only be used in locations such as military installations and correctional facilities. The manufacturer recommends that all barbed tape be installed on existing fences or walls not less than 7 ft. above ground level. This material shall also be installed in such a manner as to present a clear and highly visible element of danger, and to avoid any and all contact with pedestrian traffic. Do not attempt to conceal, disguise or transform these products under any condition or application. Eastern disclaims legal accountability from any and all damages, claims and legal actions as the result of injury caused by improper installation or failure to comply with the relevant laws, codes and ordinances applicable to these products. Be certain to check all local regulations governing security fencing products, and specific zoning requirements and restrictions as they may apply. The use of protective gloves and proper installation tools by experienced personnel is recommended.



274 Middle Island Rd.
Medford, NY 11763

1-631-698-0900
1-800-339-3362
Fax# 1-631-698-6408
www.easternfence.com

EASTERN SYSTEM 21™ FITTINGS

“The Color Fence System Of The Twenty First Century”

COLOR: BLACK-BK, EASTERN GREEN-EG, BROWN-BR

Item No.	Size	Pkg. Qty.	Description	Price Each	Pkg. Each	
ALT153	1-5/8" x 1-3/8"	200	ALUMINUM LINE TOP			
ALT213	2" x 1-3/8"	100	ALUMINUM LINE TOP			
ALT215	2" x 1-5/8"	100	ALUMINUM LINE TOP			
ALT255	2-1/2" x 1-5/8"	100	ALUMINUM LINE TOP			
GLT215	2" x 1-5/8"	100	GALVANIZED LINE TOP			
GLT255	2-1/2" x 1-5/8"	100	GALVANIZED LINE TOP			
GLT315	3" x 1-5/8"	100	GALVANIZED LINE TOP			
APC138	1-3/8"	300	ALUMINUM POST CAP			
APC158	1-5/8"	300	ALUMINUM POST CAP			
APC200	2"	250	ALUMINUM POST CAP			
APC250	2-1/2"	250	ALUMINUM POST CAP			
APC300	3"	50	ALUMINUM POST CAP			
GPC250	2-1/2"	100	GALVANIZED POST CAP			
GPC300	3"	100	GALVANIZED POST CAP			
GPC400	4"	100	GALVANIZED POST CAP			
GPC658	6-5/8"	50	GALVANIZED POST CAP			
ARE138	1-3/8"	500	ALUMINUM RAIL END			
ARE158	1-5/8"	250	ALUMINUM RAIL END			
BRE158	1-5/8"	100	GALVANIZED BRACE RAIL END			







274 Middle Island Rd.
Medford, NY 11763

1-631-698-0900
1-800-339-3362
Fax# 1-631-698-6408
www.easternfence.com

EASTERN SYSTEM 21™ FITTINGS

“The Color Fence System Of The Twenty First Century”

COLOR: BLACK-BK, EASTERN GREEN-EG, BROWN-BR

Item No.	Size	Pkg. Qty.	Description	Price Each	Pkg. Each	
BTB138	1-3/8"	300	BEVELED TENSION BAND			
BTB158	1-5/8"	250	BEVELED TENSION BAND			
BTB200	2"	250	BEVELED TENSION BAND			
BTB250	2-1/2"	200	BEVELED TENSION BAND			
BTB300	3"	200	BEVELED TENSION BAND			
BTB400	4"	150	BEVELED TENSION BAND			
BTB658	6-5/8"	100	BEVELED TENSION BAND			
BBB138	1-3/8"	300	BEVELED BRACE BAND			
BBB158	1-5/8"	300	BEVELED BRACE BAND			
BBB200	2"	250	BEVELED BRACE BAND			
BBB250	2-1/2"	200	BEVELED BRACE BAND			
BBB300	3"	150	BEVELED BRACE BAND			
BBB400	4"	150	BEVELED BRACE BAND			
BBB658	6-5/8"	50	BEVELED BRACE BAND			
GC138	1-3/8"	300	GATE CLIP			
AFT9S	NO.9 x 6-3/4"	37	ALUMINUM HOOK TIE			
AFT9L	NO.9 x 8-1/2"	31	ALUMINUM HOOK TIE			
SFT9L	NO.9 x 8-1/2"	10	STEEL HOOK TIE			
FGB3	36"	250	FIBERGLASS TENSION BAR			
FGB42	42"	250	FIBERGLASS TENSION BAR			
FGB4	48"	250	FIBERGLASS TENSION BAR			
FGB5	60"	250	FIBERGLASS TENSION BAR			
FGB6	72"	250	FIBERGLASS TENSION BAR			
FGB7	84"	250	FIBERGLASS TENSION BAR			
FGB8	96"	250	FIBERGLASS TENSION BAR			
FGB10	120"	250	FIBERGLASS TENSION BAR			
FGB12	144"	250	FIBERGLASS TENSION BAR			
STB6	72"	250	STEEL TENSION BAR			
STB8	96"	250	STEEL TENSION BAR			
STB10	120"	250	STEEL TENSION BAR			
STB12	144"	250	STEEL TENSION BAR			



04/01/12

“WHEN IT COMES TO QUALITY, SERVICE AND PRICE, NO ONE DOES IT BETTER”



274 Middle Island Rd.
Medford, NY 11763

1-631-698-0900
1-800-339-3362
Fax# 1-631-698-6408
www.easternfence.com

EASTERN SYSTEM 21™ FITTINGS

“The Color Fence System Of The Twenty First Century”

COLOR: BLACK-BK, EASTERN GREEN-EG, BROWN-BR

Item No.	Size	Pkg. Qty.	Description	Price Each	Pkg. Each
OAR138	1-3/8" x 1-3/8"	100	OARLOCK		
OAR213	2" x 1-3/8"	100	OARLOCK		
OAR215	2" x 1-5/8"	100	OARLOCK		
OAR253	2-1/2" x 1-3/8"	100	OARLOCK		
OAR255	2-1/2" x 1-5/8"	100	OARLOCK		
OAR315	3" x 1-5/8"	100	OARLOCK		
MPH200	2"	100	MALLEABLE POST HINGE		
MPH250	2-1/2"	60	MALLEABLE POST HINGE		
MPH300	3"	50	MALLEABLE POST HINGE		
MFH138	1-3/8"	100	MALLEABLE FRAME HINGE		
MFH158	1-5/8"	80	MALLEABLE FRAME HINGE		
GSL138	1-3/8"	100	GALVANIZED SLEEVE		
GSL158	1-5/8"	100	GALVANIZED SLEEVE		
SPRAY	SPRAY	12	TOUCH-UP PAINT		
NB5125	5/16" x 1-1/4"	100	NUTS AND BOLTS		
RDR	RES	25	DROP ROD		
PFH138	1-3/8"	100	GUIDE		
SCRI8	18"	50	GATE SCROLL		
AGC138	1-3/8"	100	ALUMINUM GATE CORNER		
SGC158	1-5/8"	100	STEEL GATE CORNER		
SGC200	2"	100	STEEL GATE CORNER		





274 Middle Island Rd.
Medford, NY 11763

1-631-698-0900
1-800-339-3362
Fax# 1-631-698-6408
www.easternfence.com

EASTERN SYSTEM 21™ FITTINGS

“The Color Fence System Of The Twenty First Century”

COLOR: BLACK-BK, EASTERN GREEN-EG, BROWN-BR

Item No.	Size	Pkg. Qty.	Description	Price Each
AHR	NO. 9 x 500 PCS.		ALUMINUM HOG RINGS	
CW9	NO. 9 x 1000 FT.		COIL SPRING WIRE	
CW6	NO. 6 x 1000 FT.		COIL SPRING WIRE	
BW	12-1/2" GAUGE x 4 PT. x 5" x 1320 FT.		BARB WIRE	
BA215	2" x 1-5/8"		1-PIECE BARB ARM	
BA255	2-1/2" x 1-5/8"		1-PIECE BARB ARM	
CBA250	2-1/2"		CORNER BARB ARM	
CBA300	3"		CORNER BARB ARM	
CBA400	4"		CORNER BARB ARM	
BVD215	2" x 1-5/8"	125	LINE RAIL CLAMP	
BVD255	2-1/2" x 1-5/8"	50	LINE RAIL CLAMP	
BVD315	3" x 1-5/8"	50	LINE RAIL CLAMP	
BVD138	1-3/8" x 1-3/8"	24	GATE CROSS	
BVD158	1-5/8" x 1-5/8"	24	GATE CROSS	
BVD200	2" x 2"	24	GATE CROSS	
EC215	2" x 1-5/8"	100	END RAIL CLAMP	
EC255	2-1/2" x 1-5/8"	80	END RAIL CLAMP	
EC315	3" x 1-5/8"	80	END RAIL CLAMP	
EC138	1-3/8" x 1-3/8"	24	GATE TEE	
EC158	1-5/8" x 1-5/8"	24	GATE TEE	
EC200	2" x 2"	24	GATE TEE	
IOH250	2-1/2"	12	INDUSTRIAL HINGE -180-MAL	
IOH300	3"	12	INDUSTRIAL HINGE -180-MAL	
IOH400	4"	8	INDUSTRIAL HINGE -180-MAL	
IOH658	6-5/8"	8	INDUSTRIAL HINGE -180-MAL	
ILD	1-5/8" OR 2"	24	INDUSTRIAL LOCKING DEVICE	
GHB		24	GATE HOLD BACK	
TRA	3/8" x 11"	25	TRUSS ROD	
TRT		120	TIGHTENER	



04/01/12

“WHEN IT COMES TO QUALITY, SERVICE AND PRICE, NO ONE DOES IT BETTER”